

Explorer® Digital Set-Top User's Guide

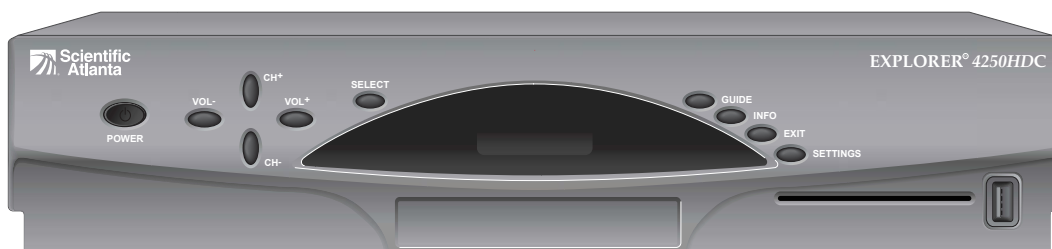

Models 4240HDC™ and 4250HDC™
with Multi-Stream CableCARD™ Interface



**Scientific
Atlanta**
A CISCO COMPANY

Notice to Installers

The servicing instructions in this notice are for use by qualified service personnel only. To reduce the risk of electric shock, do not perform any servicing other than that contained in the operating instructions, unless you are qualified to do so.

<p>Note to System Installer</p> <p>For this apparatus, the coaxial cable shield/screen shall be grounded as close as practical to the point of entry of the cable into the building. For products sold in the US and Canada, this reminder is provided to call the system installer's attention to Article 820-93 and Article 820-100 of the NEC (or Canadian Electrical Code Part 1), which provides guidelines for proper grounding of the coaxial cable shield.</p> <div data-bbox="456 646 586 762"></div> <p>This symbol is intended to alert you that uninsulated voltage within this product may have sufficient magnitude to cause electric shock. Therefore, it is dangerous to make any kind of contact with any inside part of this product.</p> <p>Ce symbole a pour but d'alerter toute personne qu'un contact avec une pièce interne de ce produit, sous tension et non isolée, pourrait être suffisant pour provoquer un choc électrique. Il est donc dangereux d'être en contact avec toute pièce interne de ce produit.</p>	<div data-bbox="878 373 1310 556"><table border="1"><tr><td>CAUTION</td></tr><tr><td>RISK OF ELECTRIC SHOCK DO NOT OPEN</td></tr><tr><td>AVIS</td></tr><tr><td>RISQUE DE CHOC ÉLECTRIQUE NE PAS OUVRIR</td></tr></table></div> <p>CAUTION: To reduce the risk of electric shock, do not remove cover (or back). No user-serviceable parts inside. Refer servicing to qualified service personnel.</p> <p>WARNING TO PREVENT FIRE OR ELECTRIC SHOCK, DO NOT EXPOSE THIS UNIT TO RAIN OR MOISTURE.</p> <div data-bbox="1036 722 1166 837"></div> <p>This symbol is intended to alert you of the presence of important operating and maintenance (servicing) instructions in the literature accompanying this product.</p> <p>Ce symbole a pour but de vous avertir qu'une documentation importante sur le fonctionnement et l'entretien accompagne ce produit.</p>	CAUTION	RISK OF ELECTRIC SHOCK DO NOT OPEN	AVIS	RISQUE DE CHOC ÉLECTRIQUE NE PAS OUVRIR
CAUTION					
RISK OF ELECTRIC SHOCK DO NOT OPEN					
AVIS					
RISQUE DE CHOC ÉLECTRIQUE NE PAS OUVRIR					

20070131 SysInstaller 820 US/Canada/Intl

U.S. Patents

A patent notice is affixed to this product. In addition, the product may also be covered by one or more of the following patents:

4,498,169; 4,692,919; 4,748,667; 4,829,569; 4,866,770; 4,885,775; 4,888,799; 4,890,319; 4,922,456; 4,922,532; 4,924,498; 4,965,534; 4,991,011; 5,003,384; 5,012,510; 5,029,207; 5,045,816; 5,053,883; 5,054,071; 5,058,160; 5,142,575; 5,142,690; 5,146,526; 5,155,590; 5,214,390; 5,225,902; 5,225,925; 5,235,619; 5,237,610; 5,239,540; 5,241,610; 5,247,364; 5,255,086; 5,257,403; 5,267,071; 5,270,809; 5,271,041; 5,272,752; 5,282,028; 5,285,497; 5,287,351; 5,301,028; 5,309,514; 5,317,391; 5,319,709; 5,341,425; 5,347,388; 5,347,389; 5,357,276; 5,359,601; 5,361,156; 5,367,571; 5,379,141; 5,379,145; 5,381,481; 5,390,337; 5,400,401; 5,406,558; 5,418,782; 5,420,866; 5,420,923; 5,425,101; 5,428,404; 5,430,568; 5,434,610; 5,436,749; 5,438,370; 5,440,632; 5,442,472; 5,455,570; 5,457,701; 5,471,492; 5,477,199; 5,477,262; 5,477,282; 5,477,370; 5,481,389; 5,481,542; 5,485,221; 5,493,339; 5,497,187; 5,500,758; 5,502,499; 5,506,904; 5,519,780; 5,539,822; 5,550,825; 5,579,055; 5,579,057; 5,583,562; 5,592,551; 5,596,606; 5,600,378; 5,602,933; 5,640,388; 5,657,414; 5,675,575; 5,684,876; 5,715,515; 5,724,525; 5,734,822; 5,740,300; 5,742,677; 5,754,940; 5,757,416; 5,771,064; 5,774,859; 5,825,829; 5,826,167; 5,850,305; 5,854,703; 5,870,474; 5,892,607; 5,920,626; 5,923,755; 5,930,024; 5,930,515; 5,937,067; 5,963,352; 5,966,163; 5,982,424; 5,991,139; 5,999,207; 6,005,631; 6,005,938; 6,016,163; 6,028,941; 6,029,046; 6,052,384; 6,055,244; 6,072,532; 6,105,134; 6,148,039; 6,157,719; 6,188,729; 6,195,389; 6,212,278; 6,215,530; 6,219,358; 6,240,103; 6,243,145; 6,246,767; 6,252,964; 6,272,226; 6,292,081; 6,292,568; 6,320,131; 6,374,275; 6,405,239; 6,411,602; 6,417,949; 6,424,714; 6,424,717; 6,433,906; 6,438,139; 6,463,586; 6,467,091; 6,476,878; 6,493,876; 6,510,519; 6,516,002; 6,516,412; 6,526,508; 6,538,595; 6,546,013; 6,560,340; 6,567,118; 6,570,888; 6,622,308; 6,629,227; 6,664,984; 6,667,994; 6,671,879; 6,674,967; 6,678,891; 6,714,598; 6,721,352; 6,721,956; 6,725,459; 6,738,982; 6,744,892; 6,744,967; 6,751,271; 6,760,918; 6,795,972; 6,802,077; 6,804,708; 6,811,447; 6,817,028; 6,822,972; 6,823,385; 6,832,386; 6,845,106; 6,868,473; 6,874,075; 6,889,191; 6,909,471; 6,917,622; 6,917,628; 6,922,412; 6,927,806; 6,928,656; 6,931,058; 6,937,729; 6,969,279; 6,971,008; 6,971,121; 6,978,310; 6,986,156; 6,988,900; 6,996,838; 7,010,801; 7,053,960; 7,065,213; 7,069,578; 7,069,572; D348065; D354959; D359737; D363932; D390217; D434753; D507240; D507535; D513407; D516518; RE36368; RE36988

20070417 Patents

Contents

Important Safety Instructions.....	iv
Welcome.....	1
Safety First	1
For More Information	1
Identify Your 4240HDC or 4250HDC	1
What's in the Carton?	2
Additional Equipment You Might Need	2
What's on the Front Panel?	3
What's on the Back Panel?	4
Connecting the Set-top.....	5
Connections for an HDTV and VCR.....	6
Connections for a Standard-Definition TV and VCR	7
View Television Programming	8
Performance Tips	9
Frequently Asked Questions.....	10
Picture Formats	11
Connecting to an HDTV with an HDMI Connector	12
Connecting to an HDTV with a DVI Connector.....	13
Connecting to an HDTV with Component Input (PrPbY).....	14
Connecting to a Home Theater System with Component Input (PrPbY).....	15
Connecting to a Stereo VCR and HDTV (optional)	16
Connecting to an HDTV with a 1394 Connector.....	17
Connecting the Set-top in HD Mode to an SDTV with Component Input (PrPbY)	17
Index.....	18
Compliance Information.....	Back Cover

IMPORTANT SAFETY INSTRUCTIONS

Read These Instructions

Keep These Instructions

Heed All Warnings

Follow All Instructions

Power Source Warning

A label on this product indicates the correct power source for this product. Operate this product only from an electrical outlet with the voltage and frequency indicated on the product label. If you are uncertain of the type of power supply to your home or business, consult your service provider or your local power company.

Ground the Product



WARNING:

Avoid electric shock and fire hazard! Do not defeat the safety purpose of the polarized or grounding-type plug. A polarized plug has two blades with one wider than the other. A grounding-type plug has two blades and a third grounding prong. The wide blade or the third prong is provided for your safety. If the provided plug does not fit into your outlet, consult an electrician for replacement of the obsolete outlet.

If this product connects to coaxial cable wiring, be sure the cable system is grounded (earthed). Grounding provides some protection against voltage surges and built-up static charges.

Outdoor Grounding System

If this product connects to an outdoor antenna or cable system, be sure the antenna or cable system is grounded (earthed). This provides some protection against voltage surges and built-up static charges.

Article 810 of the National Electric Code (NEC) ANSI/NFPA No. 70-1990, provides the following information:

- Grounding of the mast and supporting structure
- Grounding the lead-in wire to an antenna discharge unit
- Size of the grounding conductors

- Location of the antenna-discharge unit
- Connection to grounding electrodes
- Requirements for the grounding electrodes (see the following antenna grounding diagram as recommended by NEC ANSI/NFPA 70)

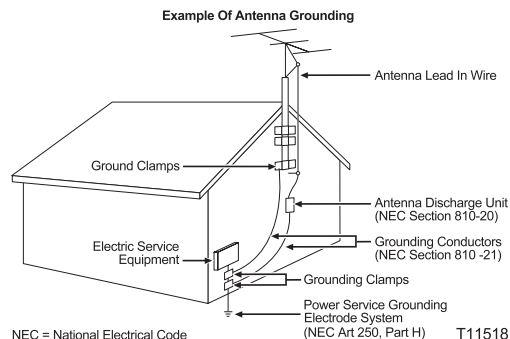

WARNING:

Avoid electric shock and fire hazard! Do not locate an outside antenna system in the vicinity of overhead power lines or power circuits. Touching power lines or circuits might be fatal.

Protect the Product from Lightning

For added protection, unplug this apparatus during lightning storms or when unused for long periods of time. In addition to disconnecting the AC power from the wall outlet, disconnect the signal inputs.

Verify the Power Source from the On/Off Power Light

When the on/off power light is not illuminated, the apparatus may still be connected to the power source. The light goes out when the apparatus is turned off, regardless of whether it is still plugged into an AC power source.

Eliminate AC Mains Overloads



WARNING:

Avoid electric shock and fire hazard! Do not overload AC mains, outlets, extension cords, or integral convenience receptacles. For products that require battery power or other power sources to operate them, refer to the operating instructions for those products.

IMPORTANT SAFETY INSTRUCTIONS, continued

Prevent Power Cord Damage

Protect the power cord from being walked on or pinched, particularly at plugs, convenience receptacles, and the point where the cord exits from the apparatus.

Provide Ventilation and Select a Location

- Do not block any ventilation openings. Install in accordance with the manufacturer's instructions.
- Do not place this apparatus on a bed, sofa, rug, or similar surface.
- Do not place this apparatus on an unstable surface.
- Do not install near any heat sources such as radiators, heat registers, stoves, or other apparatus (including amplifiers) that produce heat.
- Do not install this apparatus in an enclosure, such as a bookcase or rack, unless the installation provides proper ventilation.
- Do not place entertainment devices (such as VCRs or DVDs), lamps, books, vases with liquids, or other objects on top of this product.

Protect from Exposure to Moisture and Foreign Objects

Do not use this apparatus near water.



WARNING:
Avoid electric shock and fire hazard! Do not expose this product to liquids, rain, or moisture.



WARNING:
Avoid electric shock and fire hazard! Unplug this product before cleaning. Clean only with a dry cloth. Do not use a liquid cleaner or an aerosol cleaner. Do not use a magnetic/static cleaning device (dust remover) to clean this product.



WARNING:
Avoid electric shock and fire hazard! Never push objects through the openings in this product. Foreign objects can cause electrical shorts that can result in electric shock or fire.

Accessories Warning



WARNING:
Avoid electric shock and fire hazard! Only use attachments/accessories specified by your service provider or the manufacturer.

Service Warnings



WARNING:
Avoid electric shock! Do not open the cover of this product. Opening or removing the cover may expose you to dangerous voltages. If you open the cover, your warranty will be void. This product contains no user-serviceable parts. Refer all servicing to qualified service personnel.

Service is required when the apparatus has been damaged in any way, such as a power-supply cord or plug is damaged, liquid has been spilled or objects have fallen into the apparatus, the apparatus has been exposed to rain or moisture, does not operate normally, or has been dropped.

Check Product Safety

Upon completion of any service or repairs to this product, the service technician must perform safety checks to determine that this product is in proper operating condition.

Protect the Product when Moving It

Always disconnect the power source when moving the apparatus or connecting or disconnecting cables.



WARNING:
Avoid personal injury and damage to this product! Use only with the cart, stand, tripod, bracket, or table specified by the manufacturer or sold with the apparatus. When a cart is used, use caution when moving the cart/ apparatus combination to avoid injury from tip-over.

20070320 Set-Top Cable US & Canada

Welcome

The Explorer® 4240HDC™ and 4250HDC™ Digital Interactive Set-Tops with a Multi-Stream CableCARD™ (M-Card™) provide high-definition (HD) capability and broadband digital video services.

Follow the instructions in this guide to install the 4240HDC or 4250HDC, to become familiar with the buttons on the front panel, and to access your cable services. Then, enjoy the features of the 4240HDC or 4250HDC and change the way you watch TV!

Safety First

Before using the set-top, read the **Important Safety Instructions** section of this guide.

For More Information

The consumer support website provides news and information about this product. For more information, please refer to the following Web address:

http://www.scientificatlanta.com/products/consumers/new_cableboxes.htm

Identify Your 4240HDC or 4250HDC

To find the serial number for your 4240HDC or 4250HDC, look on the back for a label that is similar to the example shown here. The serial number begins with "STB SN" and is located beneath the bar code.

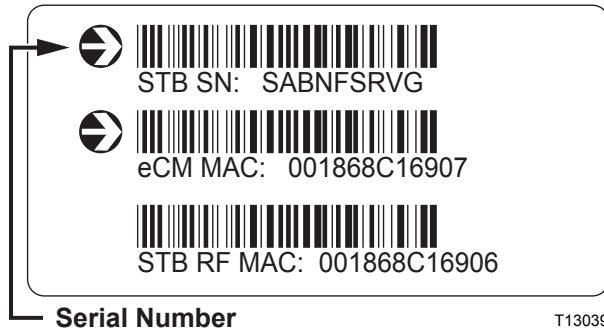

If your 4240HDC or 4250HDC requires troubleshooting in the future, your service provider may ask for this serial number.

Use the space provided here to record the serial number:

What's In The Carton?

The set-top carton contains the following items:



• 4240HDC or 4250HDC Set-top



• Connection Guide

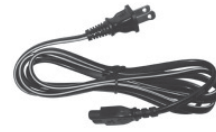

• Power Cord



• Component Video Cables (PrPbY)



• Audio Left/Right Cable

Additional Equipment You Might Need

You might need some of the cables and adapters shown below for connecting the set-top to your home entertainment devices. See the connection information beginning on page 12 for more information.

Check with your service provider for information about acquiring cables or adapters, or you can purchase cables or adapters at your local electronics supplier.



Multi-Stream CableCARD (obtain from your service provider)



Composite A/V Cables



HDMI Adapter



S-Video Cable



RGB Adapter Cable (RCA to RCA)



RGB Adapter



HDMI-to-HDMI Cable



RGB Adapter Cable (RCA to BNC)



RGB Adapter Cable (RCA to VGA)



HDMI-to-DVI Cable



Optical Digital Audio Cable



IEEE 1394 6-Pin to 4-Pin Cable



RF Coaxial Cable



Coaxial Digital Audio Cable



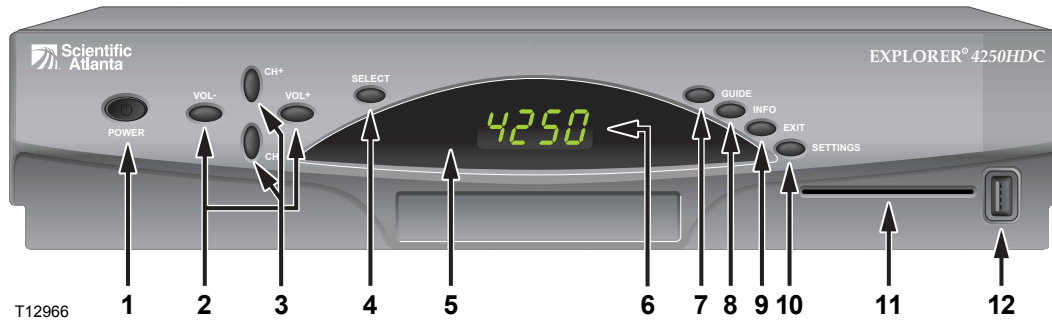

IR Extender Cable

What's on the Front Panel?



T12966

- | | |
|---------------------------|--|
| 1 Power | Turns the set-top on and off |
| 2 VOL +, VOL - | Increases and decreases the volume |
| 3 CH+, CH - | Scrolls up and down through the channels |
| 4 Select | Provides access to your on-screen selection |
| 5 IR Sensor | Receives the infrared signal from the remote control |
| 6 LED Display | Displays the selected channel number and time of day. The LED also displays the following: <ul style="list-style-type: none">• Message ()• HDTV• Power ()• Output Resolution (1080i, 720p, 480p, or 480i)• AUTO (Automatically outputs native scan rates that your TV can accept) |
| 7 Guide | Accesses on-screen services, such as the on-screen guide, video-on-demand, or pay-per-view |
| 8 Info | Displays a description of the selected program. This button is available from the on-screen guide and while viewing a program |
| 9 Exit | Exits menus, the on-screen guide, and program information |
| 10 Settings | Provides access to the Settings menu |
| 11 Smart Card Slot | Reserved for future use |
| 12 USB Port | Connects to external equipment, such as a keyboard or mouse (reserved for future use) |

Note: This illustration may vary from the actual product.

What's on the Back Panel?

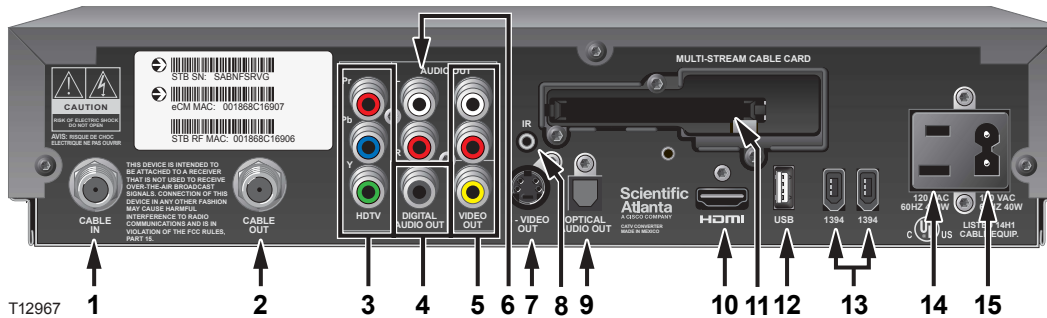

T12967

- 1 Cable In** Connects to a coaxial cable that delivers the signal from your service provider
- 2 Cable Out** Connects to a coaxial cable that sends analog audio and video signals to a TV or VCR. These signals are standard-definition TV (SDTV) video and stereo audio
- 3 HDTV** Connects to the component video input (YPbPr) on the HDTV, when in HD mode
- 4 Digital Audio Out** Connects to an RCA cable that sends a digital audio signal to a surround-sound receiver or other digital audio device
- 5 Out 2 (Secondary Video/ Audio Out)** Connects to either a VCR or to another set of inputs (composite) on your TV
- 6 Audio Out (Left, Right)** Connects to RCA cables that send analog audio signals (left and right) to the stereo inputs on a TV
- 7 S-Video Out** Connects to an S-Video cable that sends an S-Video signal to your TV or VCR. This signal is standard definition, but higher quality than other SDTV connections
- 8 IR** This connector reserved for future use
- 9 Optical Audio Output** Connects to an optical cable that sends a digital audio signal to a surround-sound receiver or other digital audio device
- 10 HDMI** Connects an HDMI™ cable to the HDMI input of an HDTV. HDMI supports both digital audio and video. May be used to connect to a DVI interface using an HDMI-to-DVI adaptor for video and separate audio connections. Any of the following audio connections may be used: Digital Audio Out (4); Audio Out: Left, Right (6); or Optical Audio Output (9)
- 11 Multi-Stream CableCARD** Slot for Multi-Stream CableCARD (M-Card) module, which decrypts subscription digital channels. This set-top will not operate correctly without an M-Card module. Obtain an M-Card module from your service provider
- 12 USB** Connects to external USB devices such as a keyboard or a mouse
- 13 1394** Connects to display devices that are equipped with a 1394 input
- 14 AC Outlet** Connects to the AC power cord from another device, such as a TV
- 15 AC Power Input** Connects to the power cord to deliver power to the set-top

Note: This illustration may vary from the actual product.

Connecting the Set-top

To connect your set-top to your entertainment devices, complete these steps.



Determine if your TV is HD or SD and whether it is wide screen (16:9) or standard screen (4:3). **See page 11** for more information.



or

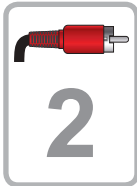

Make the connections for your TV and/or VCR as follows:

- If you are using an HDTV, **see page 6** and the connection diagrams at the end of this guide.
- If you are using an SDTV, **see page 7** and the connection diagrams at the end of this guide.
- If you want to archive some programs to VCR tape, **see pages 6 and 7** and the connection diagrams at the end of this guide.



Identify the additional devices you will connect to the set-top and TV. **See pages 12 through 17** and the related user guides for your devices for more information.

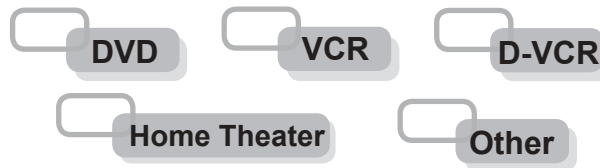

Plug the set-top and the TV into an AC power source that is not controlled by a switch.

To provide some protection against voltage surges and built-up static charges that can be caused by lightning storms and power outages, ground (earth) your electronic devices, such as by plugging the set-top into a surge protector.



Do not turn on the set-top or TV yet.



It may take several minutes for the set-top to receive the latest software, programming, and service information. Wait until you see one of the following displays on the front panel of the set-top that indicates that the update is complete:

- Current time
- Four dashes (----)

Note: If four dashes are displayed, you must call your service provider to get the set-top authorized.

















































Set up your set-top for HDTV or SDTV by completing the following steps:

- Make sure the set-top is **Off** and the TV is **On**.
- On the front panel of the set-top, press **GUIDE** and **INFO** at the same time.
- Follow the on-screen instructions to choose **HD** or **SD** mode and wide screen (16:9) or standard screen (4:3) depending upon your TV type. **See page 11** for more information on the scan rate.
- At the conclusion of the on-screen instructions, press **POWER** on the set-top to begin watching TV.

Connections for an HDTV and VCR

To use the set-top with an HDTV, you must make *one* of the following connections to view the HD content. In addition, you can make connections to a digital or analog VCR to record to a VCR tape. Refer to your TV and VCR user's guides and the cabling diagrams in this guide for more detailed connection information.









Note: The labeling on your set-top may vary slightly.

Required Connections to an HDTV (use one)		Set-top Connections	HDTV Connections
HDMI	Some HDTVs have a High-Definition Multimedia Interface (HDMI) connector. The HDMI connector provides both a digital video and audio connection. See the connection diagram on page 12 for an example.		
DVI	The HDMI connector can provide the connection to an HDTV with a DVI input. If your HDTV has a Digital Visual Interface (DVI) connector, you will need an HDMI-to-DVI adapter, and you will need to connect a separate audio connection. See the connection diagram on page 13 for an example.	 OUT 1  L  R Adapter Needed	 DVI  L  R
PrPbY	The PrPbY connectors can provide high-definition component video signals to an HDTV. Note: Use the HD Setup Wizard on the set-top to set the HD mode and select the output video format that will matches the full capabilities of your HDTV. See the connection diagram on page 14 for an example.	Pr  OUT 1 Pb  L Y  R	Y  L R Pb  L R Pr  L R
RGB	Some HDTVs have only RGB connectors. If you have one of these HDTVs, you need an RGB adapter, and you will need to connect a separate audio connection. Check with your service provider for information about acquiring an RGB adapter, or you can purchase the adapter at your local electronics supplier.	Pr  OUT 1 Pb  L Y  R RGB Adapter Needed	R  H G  V B  L R  
1394	Some HDTVs have 1394 connectors. If you connect to your HDTV using a 1394 connection, you also need to connect separate video and audio connections to your HDTV. See the connection diagram on page 17 for an example.	Pr  1394 OUT 1 Pb  L Y  R	Y  1394  L R Pb  L R Pr  L R
Optional Connections to a VCR (use one)		Set-top Connections	VCR Connections
VCR	For VCRs with Video and Left and Right audio connectors, you can use the Out 2 connectors (Video, Left, and Right) on the set-top. See the connection diagram on page 16 for an example.	OUT 2  A  U  D  I  O VIDEO	 VIDEO IN  L  R  AUDIO IN
	For VCRs with S-Video and Left and Right audio connectors, you can use the S-Video Out and the Out 2 Left and Right connectors on the set-top.	 S-VIDEO OUT OUT 2  L  R	 S-VIDEO IN  L  R
	For <i>Digital VCRs</i> , you can use the 1394 out connector on the set-top.	1394 	1394 

Connections for a Standard-Definition TV and VCR

When using the set-top with an SDTV, you must make *one* of the following connections to view content. Some SDTVs may not have all these connections. In addition, you can make connections to a VCR to record to a VCR tape. Refer to your TV and VCR user's guides and the cabling diagrams in this guide for more detailed information.

Note: The labeling on your set-top may vary slightly.

Required Connections to an SDTV (use one)		Set-top Connections	SDTV Connections
PrPbY	<p>The PrPbY connectors can provide standard-definition component video signals to an SDTV.</p> <p>Note: To connect PrPbY to an SDTV, you must set the HD Setup Wizard on the set-top to HD Mode, and select the output video format (typically 480i) that will match the capabilities of your SDTV.</p>		
S-Video	<p>The S-Video Out connection provides an optimal video connection to SDTVs.</p>		
Cable Out	<p>The Cable Out connector provides a video and audio connection to an SDTV.</p>		
Optional Connection to a VCR		Set-top Connections	VCR Connections
VCR	<p>For VCRs with Video and Left and Right Audio connectors, you can use the Out 2 connectors (Video, Left, and Right) on the set-top.</p>		

View Television Programming

Access Services and Programs

Access cable services and programs by pressing the following keys on the remote control:

- **Guide**—Access the on-screen guide. The on-screen guide displays schedules of TV programs and other services available from your cable service provider, such as video-on-demand and pay-per-view programs.
- **Arrows**—Select a program in the schedule.
- **Info**—Display a specific program description (either from the on-screen guide or while viewing a program).
- **Select**—View a specific program in the guide.

Stretch and Zoom Program

You can stretch and zoom SD or HD programs by pressing the # key on the remote control.

Avoid Screen Burn-In!

Images such as letterbox bars or side bars, bright closed-captioning backgrounds, station logos, or any other stationary images may cause the screen in your HDTV to age unevenly; this is known as screen burn-in. Refer to the user's guide that came with your HDTV for more information.



WARNING:

Avoid screen burn-in!

Do not display the same fixed images on your HDTV screen for extended periods of time.

Performance Tips

If the set-top does not perform as expected, the following tips may help. If you need further assistance, contact your service provider.

No Picture

- Verify that the power to your TV is turned on.
- Verify that your HDTV is in HD mode. If necessary, run the HD Setup Wizard to select HD mode.
- If the set-top is plugged into a wall switch, verify that the switch is in the ON position.
- Verify that all cables are properly connected.
- Verify that the M-Card module is installed.
- If your system includes a VCR or stereo, verify that you have properly connected them to the set-top
- Verify that the set-top is set to the proper screen type and resolution.

No Color

- Verify that the current TV program is broadcast in color.
- Adjust the TV color controls.
- If you are using a component video connection (PrPbY), check that all connectors are completely plugged into the set-top and TV.

No Sound

- If your setup includes a VCR or stereo, verify that you have properly connected them to the set-top.
- Verify that the volume is turned up (analog audio only).
- Verify that the mute function is not on (analog audio only).

Automatic Software Updates

A message appears on the TV screen when the set-top and the M-Card module are receiving software updates. In addition, download information also appears on the front panel of the set-top during these updates. Wait for the current time to display on the front panel before continuing. When the time appears, the update is complete.

Frequently Asked Questions

What is Digital Television?

Digital television (DTV) is a huge leap forward in television technology compared to analog television that has been widely available since the 1940s. DTV is delivered and displayed using digital encoding, similar to the way a PC operates. By using digital technology, there is no variation in picture and sound quality from the origination point until it is displayed on your television. You always receive a high-quality picture without the wavy lines or static you might sometimes get from a weak analog signal.

Because DTV receives and displays digital images that contain many times more picture elements (pixels - the small dots that make up the color image on your screen) than standard analog television, you can get a sharper on-screen image than with analog. Additionally, DTV supports CD-quality sound. DTV includes SDTV (Standard Definition Television), EDTV (Enhanced Definition Television), and HDTV (High-Definition Television). That means that all HDTV is digital, but not all digital TV is high-definition. A high-definition program must originate in HD format and be broadcast in HD format. Having an HDTV system does not mean that everything you watch will be in high-definition. Getting the signal from digital cable also does not mean it is high-definition.

What is Standard-Definition Television?

Standard-definition television (SDTV) is basic digital television programming delivered by cable. Typically, the SDTV screen is the same, nearly square shape as an analog television screen. Digital images on an SDTV set are crisp and clear—noticeably better than on a standard analog television set using an antenna to receive over-the-air signals.

What is High-Definition Television?

High-definition television (HDTV) is a completely new way to send and receive television broadcast signals. HDTV images are made up of pixels that are much smaller and closer together than those used in standard analog television, and there are millions of them. Thus, HDTV can display five to six times the detail of analog television to deliver picture quality that is much more realistic, dimensional, and precise. SDTV programs can be viewed on an HDTV. Another feature of HDTV is digital surround sound using Dolby® Digital, which is the same technology used to produce the sound you hear in movie theaters.

Are Local TV Stations Broadcasting in HDTV?

Many local TV stations are transmitting digital signals. However, transmitting a digital signal does not mean transmitting an HDTV signal. Some stations are using the new bandwidth to broadcast several standard-definition channels. Most stations, once they begin broadcasting in digital, are offering HD content from their parent network (for example, CBS, ABC, NBC, Fox, WB, UPN, and PBS).

What is an M-Card Module?

An M-Card module is a CableCard that allows the set-top to decrypt subscription digital channels. The module fits into the Multi-Stream slot on the back of the set-top (see page 4 for the location of the slot). You can obtain an M-Card module from your service provider.

Note: Your service provider may provide this when you first receive the set-top.

Where Are the Connection Diagrams?

The diagrams at the end of this guide show examples of common ways to connect the set-top to your other electronic devices. However, these diagrams do not show every possible combination of devices. Refer to the user's guides that came with your other electronic devices for further information.

What Cables Do I Need?

Some of the cables and adaptors shown in the diagrams may not be included with the set-top. Some of the required cables are shown in the connection diagrams and on page 2 of this guide.

Picture Formats

What is the Difference Between a Standard-Screen and a Wide-Screen HDTV

The type of screen your HDTV has (wide screen or standard screen) determines how the set-top displays programs on the screen. The picture format for an HDTV is a combination of *aspect ratio* and *screen resolution* and is different for standard-screen and wide-screen HDTVs.

What is Aspect Ratio?

An aspect ratio is the ratio of the width to the height of the TV screen. The aspect ratios differ because the television industry manufactures both standard-screen and wide-screen HDTVs to appeal to consumer viewing preferences.

What is the Screen Resolution and Scan Rate?

The screen resolution indicates the amount of detail that the picture displays. Resolution is identified by the number of display lines on the screen. The techniques that an HDTV uses to “paint” the picture on the screen are referred to as progressive and interlaced.



With the **progressive method**, the lines are drawn on the screen one at a time in sequential order. The **interlaced method** involves refreshing pixels in alternation — first the odd lines and then the even lines.

For advance setup, select the scan modes that your TV can support. Refer to your set-top and HDTV user’s guides to choose the proper scan rates (480i, 480p, 720p, 1080i) for your setup.

For example, a resolution of 1080i indicates that the screen shows 1080 lines in an interlaced display, and 480p indicates that the screens shows 480 lines in a progressive display.

Notes:

- The screen resolution (1080i, 480p, and so forth) is sometimes referred to as the scan rate. The terms are interchangeable.
- You can stretch and zoom the displayed picture using the built-in capability of the set-top by pressing the # key on the remote control.

<p>A standard-screen HDTV has a 4x3 aspect ratio. The screen is 4 units wide for every 3 units tall.</p>  <p>A screen resolution of 480p or 480i fills the screen.</p>	<p>A wide-screen HDTV is one-third wider than a standard-screen HDTV. The screen is 16 units wide for every 9 units tall.</p>  <p>A screen resolution of 720p or 1080i fills the screen.</p>
--	---

Connecting to an HDTV with an HDMI Connector



WARNING:

Electric shock hazard! Unplug all electronic devices before connecting or disconnecting any device cables to the set-top.

Required cables:

- 1 HDMI-to-HDMI cable

Explorer Set-top

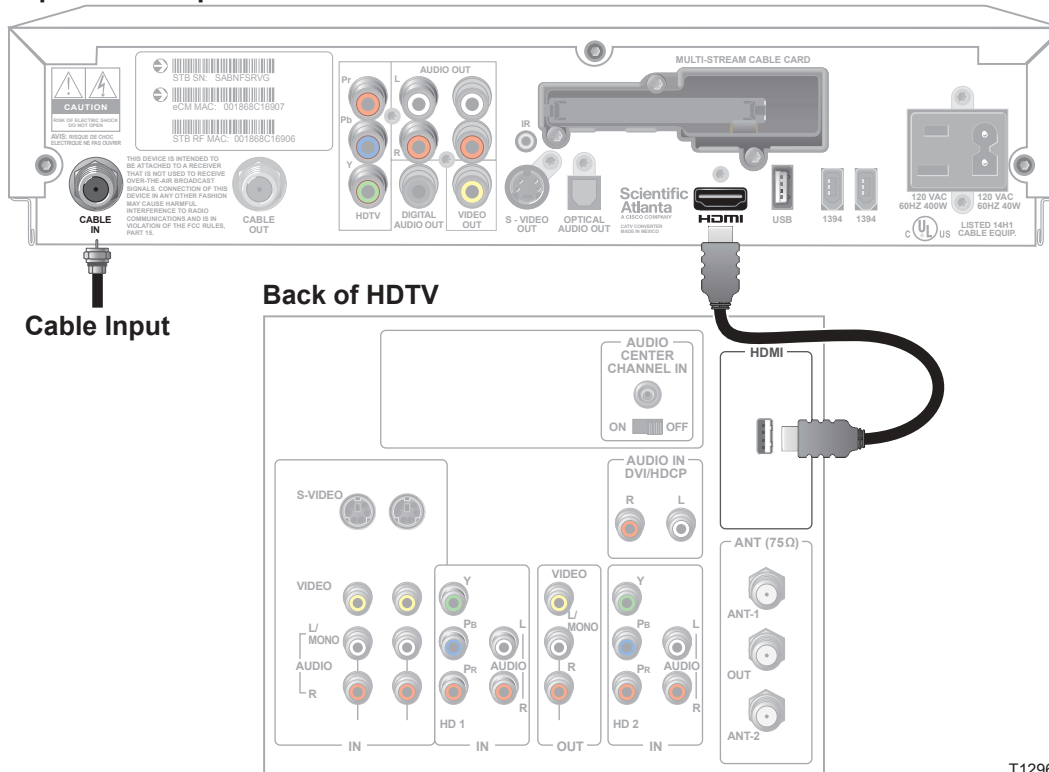

T12968

Important Notes Regarding the HDMI Interface on the Set-Top

The HDMI interface automatically configures the audio output for a format supported by the television. Because not all TVs support the Dolby® Digital input, the HDMI interface may automatically select a 2-channel stereo audio configuration instead of Dolby Digital, which it carries over to the other digital audio outputs of the set-top. This prevents your home theater system or Dolby Digital decoder from providing the full Dolby Digital surround-sound effect.

You can override this configuration by completing the following steps.

1. Press **SETTINGS** twice on the remote control to open the General Settings menu.
2. Press **MOVE UP** or **MOVE DOWN** to select the option Audio: Digital Out.
3. Press **MOVE RIGHT** to select Dolby Digital. This setting will send Dolby Digital audio to the HDMI, DIGITAL AUDIO OUT, and OPTICAL AUDIO OUT connectors on the set-top.

Notes:

- If the TV is not Dolby Digital capable, it may not produce audio through its speakers when the Audio: Digital Out setting on the set-top is set to Dolby Digital. You can either switch the Audio: Digital Out setting back to HDMI when you are not using the home theater or Dolby Digital decoder, or you can connect the baseband audio outputs (OUT 1 Audio Left and Right) to the TV.
- Digital content is encrypted with High-Bandwidth Content Protection (HDCP) on the DVI/HDMI port. This set-top is not compatible with devices that do not support HDCP. You must use either the PrPbY or 1394 connection to connect the set-top to these devices.

Connecting to an HDTV with a DVI Connector



WARNING:

Electric shock hazard! Unplug all electronic devices before connecting or disconnecting any device cables to the set-top.

Required cables:

- 1 HDMI-to-DVI or 1 HDMI-to-HDMI cable and 1 DVI adapter
- 1 audio Left/Right cable

Explorer Set-top

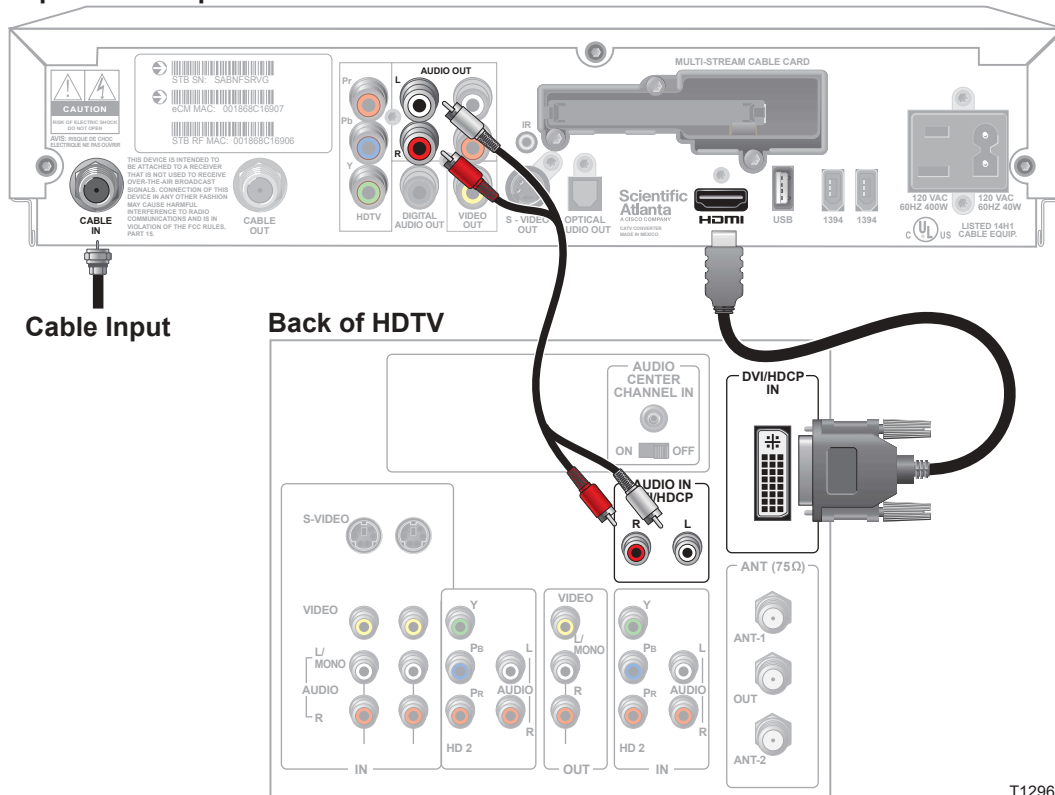

T12969

Notes:

- When you connect the HDMI connector to the DVI connector on your HDTV, you need an HDMI-to-DVI adaptor and a separate audio connection.
- Digital content is encrypted with High-Bandwidth Content Protection (HDCP) on the DVI/HDMI port. This set-top is not compatible with devices that do not support HDCP. You must use either the PrPbY or 1394 connection (which uses Digital Transmission Content Protection, or DTCP) to connect the set-top to these devices.
- Also refer to the **Important Notes Regarding the HDMI Interface on the Set-top** on page 12.

Connecting to an HDTV with Component Input (PrPbY)



WARNING:

Electric shock hazard! Unplug all electronic devices before connecting or disconnecting any device cables to the set-top.

Required cables:

- 1 set component video cables (PrPbY)
- 1 audio Left/Right cable

Explorer Set-top

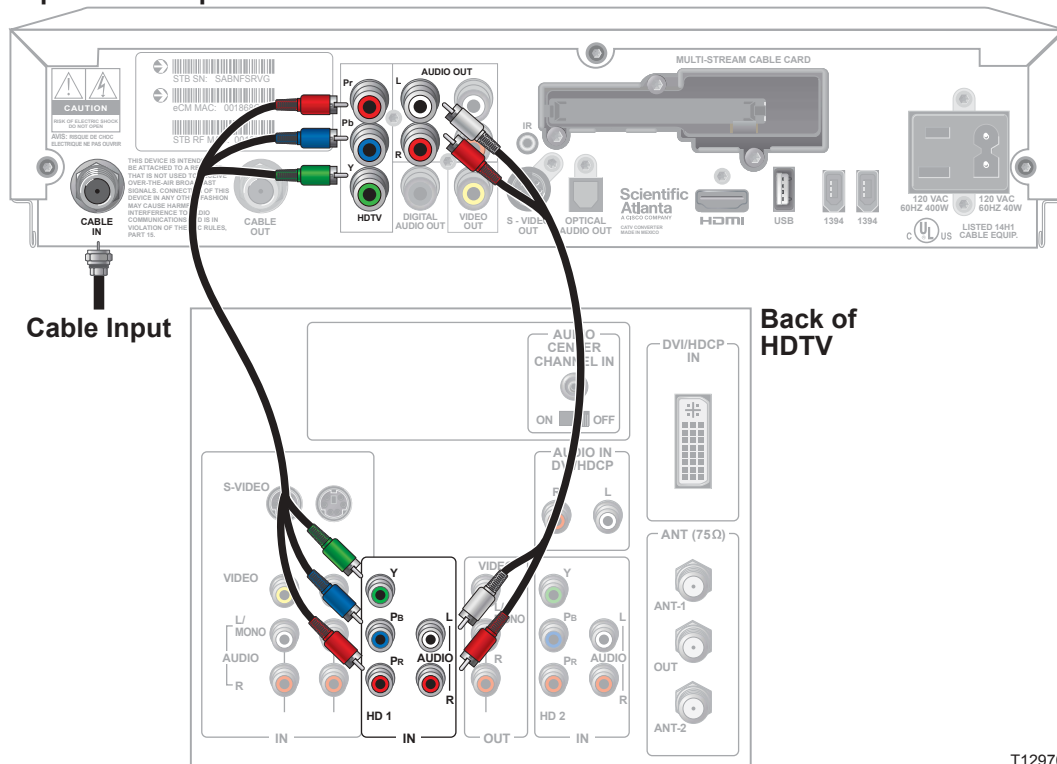

T12970

Connecting to a Home Theater System with Component Input (PrPbY)

Required cables:

- 3 sets component video cables (PrPbY)
- 2 coaxial digital audio cables
- 1 audio Left/Right cable
- 1 video cable

Explorer Set-top

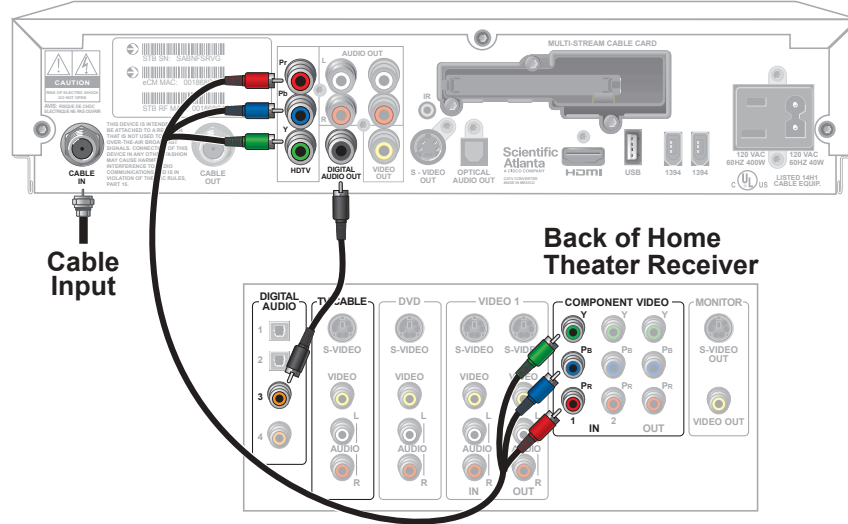

T12971



WARNING:

Electric shock hazard! Unplug all electronic devices before connecting or disconnecting any device cables to the set-top.

Back of Home Theater Receiver

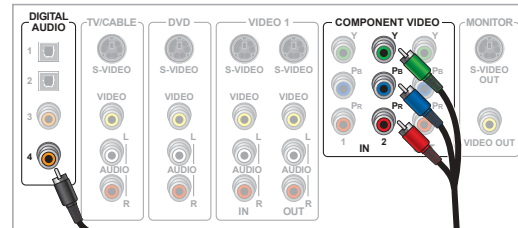

Back of Home Theater Receiver

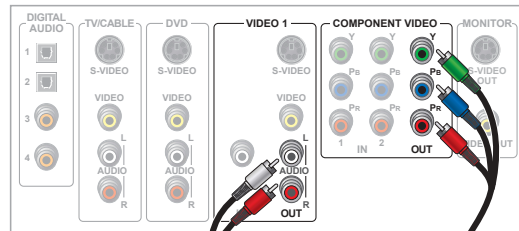

Back of DVD Player

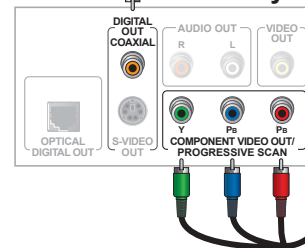

T11135

Back of HDTV

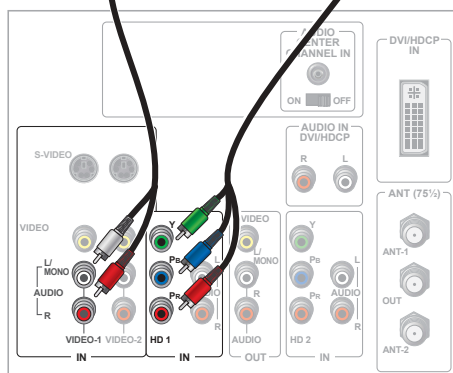

T13087

Note: This connection assumes that audio is provided by the home theater speakers.

Connecting to a Stereo VCR and HDTV (optional)



WARNING:

Electric shock hazard! Unplug all electronic devices before connecting or disconnecting any device cables to the set-top.

Required cables:

- 1 RF coaxial cable
- 2 sets composite A/V cables

Explorer Set-top

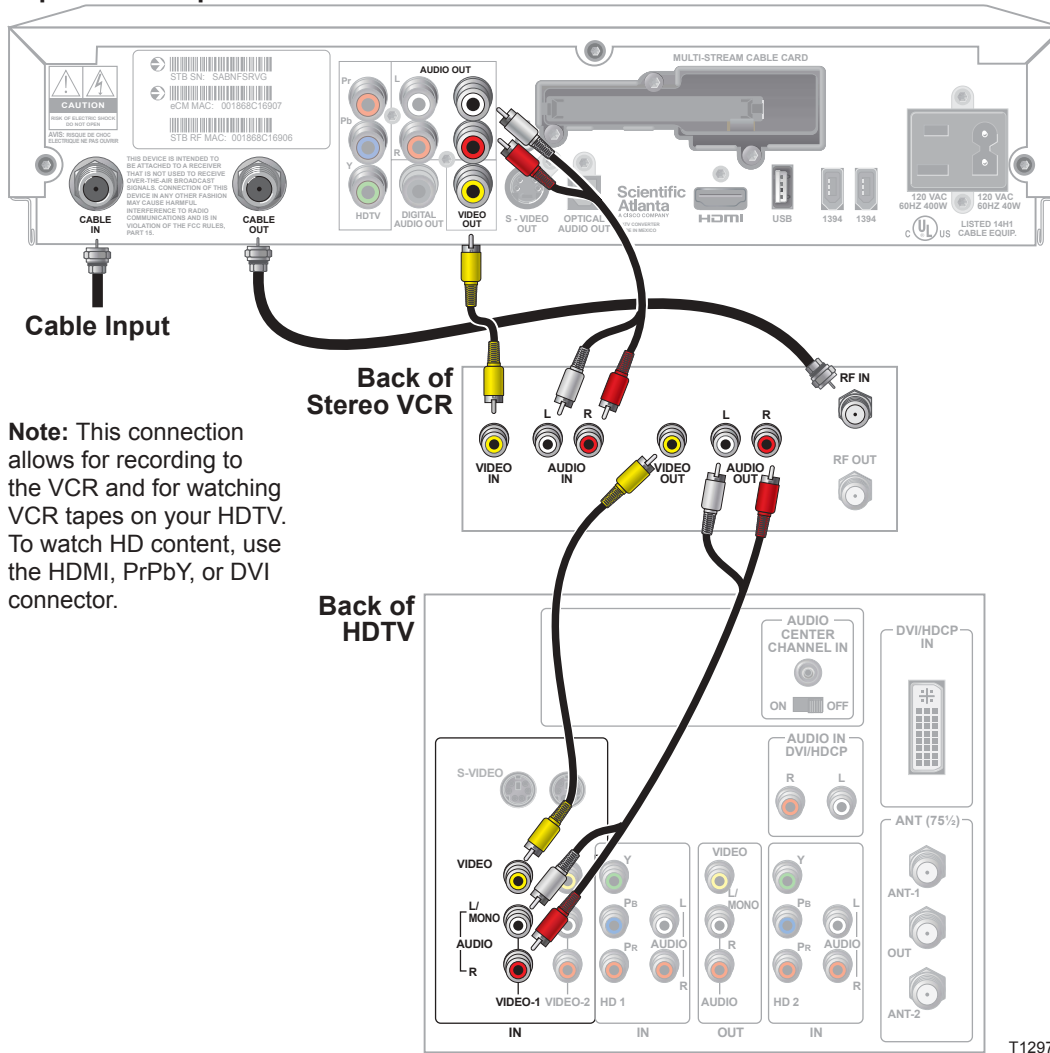

T12972

Connecting to an HDTV with a 1394 Connector

Required cables:

- 1 6-pin to 4-pin 1394 cable (Consult your TV user's guides for more detailed information)
- 1 set component A/V cables
- 1 set audio Left/Right cables

Explorer Set-top

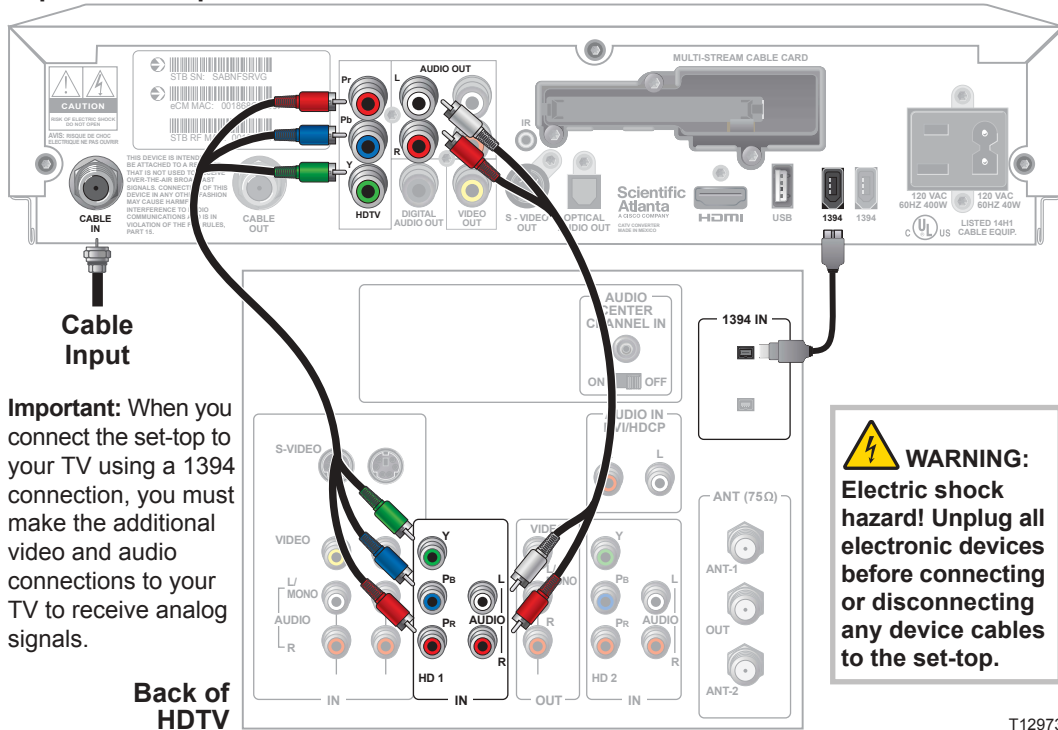

Connecting the Set-top in HD Mode to an SDTV with Component Input (PrPbY)

WARNING:
Electric shock hazard! Unplug all electronic devices before connecting or disconnecting any device cables to the set-top.

Explorer Set-top

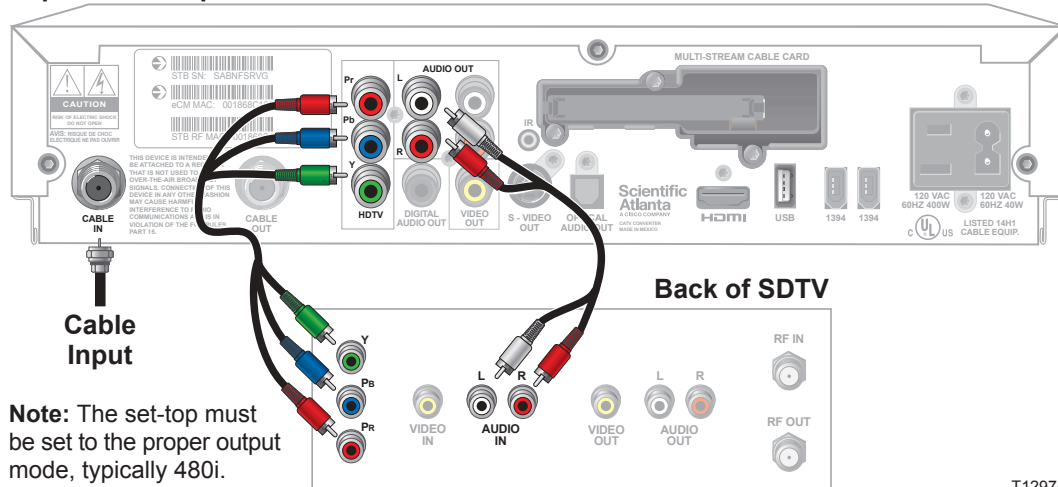

Index

1394 4, 6, 17

A

AC

Outlet iv, 4

Power input 4

Aspect ratio 11

B

Back panel 4

Burn-in of screen 8

C

CableCard 2, 4, 10

Cables 2

Cable Out, connector 4

Compliance, FCC and Canadian EMI Back Cover

Component video connection. *See* PrPbY

Composite 7

Connectors

See also Front panel; Back panel

required for HDTV 6

required for SDTV 7

VCR 6, 7

Connecting the set-top to other devices;

HDTV with 1394 connector 17

HDTV with component input (PrPbY) 14

HDTV with DVI connector 13

HDTV with HDMI connector 12

HDTV with VCR 16

Home Theater System with component input (PrPbY) 15

SDTV 17

Consumer support 1

Controls. *See* Front panel

D

Dashes display 5

Diagrams. *See* Connecting the set-top to other devices

Digital TV, What is it 10

Display, LED 3

DVI connector 2, 4, 6, 13

F

FAQs 10

FCC compliance Back Cover

Formats, picture 11

Frequently Asked Questions. *See* FAQs

Front panel 3

H

HD

broadcasting 10

mode 4, 5, 6, 7, 17

format 1, 10

HDTV

Connections 6

formats 11

What is it 10

HDMI 4, 6, 12

High-definition. *See* HD

Home theater system connection 15

I

Interlaced scan rate 11

IR Sensor 3

K

Keys. *See* Front panel; Back panel

L

LED Display 3

M

M-Card. *See* Multi-Stream CableCARD

Multi-Stream CableCARD 2, 4, 10

Index, continued

P

Performance tips. *See* Troubleshooting.

Picture

Doesn't display 9

Formats 11

No color 9

Picture-in-picture. *See* PIP

PIP 8

Ports. *See* Connectors

Product information 1

Programming, viewing 8

Progressive scan rate 11

PrPbY

connector 4, 6, 7

HDTV connection 14

home theater connection 15

SDTV connection 17

R

Remote control 8

RGB connector. *See* PrPbY

S

S-Video 7

Safety ii, iv-v

Scan rates 11

Screen

burn-in 8

resolution 11

size 11

SD mode 4, 5, 7, 17

SDTV

Connections 7, 17

What is it 10

Serial number, locating 1

Set-top. *See* Welcome

Software updates 9

Sound, troubleshooting 9

Standard-definition, What is it 10

Standard screen TV 11

Stretching and zooming picture 8, 11

Support, consumer 1

T

Time display 5

Troubleshooting 9

TV

digital, what is it 10

formats 11

HDTV, what is it 10

programming 8

resolution 11

standard screen 11

standard-definition, What is it 10

wide screen 11

U

Updating, software 9

USB port 3

V

VCR connection 6, 7, 16

View programs 8

W

Watch TV 1, 8

Web access to product information 1

Welcome 1

Widescreen TV 11

Y

YPbPr. *See* PrPbY

Z

Zoom picture 8, 11

FCC Compliance

United States FCC Compliance

This device has been tested and found to comply with the limits for a Class B digital device, pursuant to part 15 of the FCC Rules. These limits are designed to provide reasonable protection against such interference in a residential installation. This equipment generates, uses, and can radiate radio frequency energy. If not installed and used in accordance with the instructions, it may cause harmful interference to radio communications. However, there is no guarantee that interference will not occur in a particular installation. If this equipment does cause harmful interference to radio or television reception, which can be determined by turning the equipment OFF and ON, the user is encouraged to try to correct the interference by one or more of the following measures:

- Reorient or relocate the receiving antenna, if applicable.
- Increase the separation between the equipment and receiver.
- Connect the equipment into an outlet on a circuit different from that to which the receiver is connected.
- Consult the cable company or an experienced radio/television technician for help.

Any changes or modifications not expressly approved by Scientific-Atlanta, Inc., could void the user's authority to operate the equipment.

The information shown in the FCC Declaration of Conformity paragraph below is a requirement of the FCC and is intended to supply you with information regarding the FCC approval of this device. The phone numbers listed are for FCC-related questions only and not intended for questions regarding the connection or operation for this device. Please contact your cable service provider for any questions you may have regarding the operation or installation of this device.

FCC Declaration of Conformity

This device complies with Part 15 of FCC Rules. Operation is subject to the following two conditions:
1) the device may not cause harmful interference, and
2) the device must accept any interference received, including interference that may cause undesired operation.

EXPLORER 4240HDC and 4250HDC
Digital Interactive Set-top
Model: 4240HDC and 4250HDC
Manufactured by: Scientific-Atlanta, Inc.;
5030 Sugarloaf Parkway;
Lawrenceville, Georgia 30044; USA
Telephone 770-236-1077



Scientific Atlanta, A Cisco Company
5030 Sugarloaf Parkway
Box 465447
Lawrenceville, GA 30042

This document includes various trademarks of Scientific-Atlanta, Inc. Please see the Trademarks section of this document for a list of the Scientific-Atlanta, Inc., trademarks used in this document. All other trademarks shown are trademarks of their respective owners.

Product and service availability is subject to change without notice.

© 2007 by Scientific-Atlanta, Inc. All rights reserved.
July 2007

Canada EMI Regulation

This Class B digital apparatus complies with Canadian ICES-003.

Cet appareil numérique de la class B est conforme à la norme NMB-003 du Canada.

20060628FDC

Software and Firmware Use

Scientific-Atlanta, Inc. owns copyrights to the software included in your set-top and furnishes the software to your cable service provider under a license agreement. You may only use or copy this software in accordance with the terms of your cable service provider.

Scientific-Atlanta, Inc. owns copyrights to the firmware in this equipment. You may only use the firmware in the equipment in which it is provided. Any reproduction or distribution of this firmware, or any portion of it, without the express written consent of Scientific-Atlanta, Inc. is prohibited.

Trademarks

Scientific Atlanta, the Scientific Atlanta logo, and Explorer are registered trademarks of Scientific-Atlanta, Inc.

4240HDC, 4250HDC, and Multi-Room are trademarks of Scientific-Atlanta, Inc.

Cisco, the Cisco logo, and Cisco Systems are trademarks or registered trademarks of Cisco Systems, Inc. and/or its affiliates in the U.S. and certain other countries.

CableCARD and M-Card are trademarks of Cable Television Laboratories, Inc.

Manufactured under license from Dolby Laboratories. Dolby is a trademark of Dolby Laboratories.

HDMI, the HDMI logo, and High-Definition Multimedia Interface are trademarks or registered trademarks of HDMI Licensing LLC.

Macrovision is a registered trademark of Macrovision Corp.

All other trademarks shown are trademarks of their respective owners.

Disclaimer

Scientific-Atlanta, Inc. assumes no responsibility for errors or omissions that may appear in this guide. Scientific-Atlanta, Inc. reserves the right to change this guide at any time without notice.

770.236.5000
www.scientificatlanta.com

Printed in United States of America

4015107 Rev A