



Cisco CIS430 High-Definition IPTV Set-Top with DVR



Contents

IMPORTANT SAFETY INSTRUCTIONS.....	4
Change the Way You Watch TV	6
Safety First	6
Serial Number.....	6
In This Manual	6
Front Panel Features.....	7
Back Panel Connectors	8
Connecting Your Set-Top.....	9
Connecting to the Home Network.....	10
Connections for an HDTV.....	11
Connections for an SDTV.....	12
Connections for a VCR or a DVD Recorder	13
Connecting to an HDTV with an HDMI Connector	14
Connecting to an HDTV with a DVI Connector.....	15
Connecting to an HDTV with Component (YPbPr) Connectors	16
Connecting to a Home Theater System with Component (YPbPr) Connectors	17
Connecting to a Stereo VCR or DVD Recorder (optional).....	18
Connecting to an SDTV with Component (YPbPr) Connectors.....	19
Connecting to an SDTV with an RCA-Type Connector	20
Connecting to an SDTV with a Coaxial Cable.....	21
Troubleshooting.....	22
Avoiding Screen Burn-In.....	22
Frequently Asked Questions.....	23
Picture Formats	24
Index.....	25
Compliance Information.....	27

IMPORTANT SAFETY INSTRUCTIONS

- 1) Read these instructions.
- 2) Keep these instructions.
- 3) Heed all warnings.
- 4) Follow all instructions.
- 5) Do not use this apparatus near water.
- 6) Clean only with dry cloth.
- 7) Do not block any ventilation openings. Install in accordance with the manufacturer's instructions.
- 8) Do not install near any heat sources such as radiators, heat registers, stoves, or other apparatus (including amplifiers) that produce heat.
- 9) Do not defeat the safety purpose of the polarized or grounding-type plug. A polarized plug has two blades with one wider than the other. A grounding-type plug has two blades and a third grounding prong. The wide blade or the third prong are provided for your safety. If the provided plug does not fit into your outlet, consult an electrician for replacement of the obsolete outlet.
- 10) Protect the power cord from being walked on or pinched particularly at plugs, convenience receptacles, and the point where they exit from the apparatus.
- 11) Only use attachments/accessories specified by the manufacturer.
- 12)  Use only with the cart, stand, tripod, bracket, or table specified by the manufacturer, or sold with the apparatus. When a cart is used, use caution when moving the cart/apparatus combination to avoid injury from tip-over.
- 13) Unplug this apparatus during lightning storms or when unused for long periods of time.
- 14) Refer all servicing to qualified service personnel. Servicing is required when the apparatus has been damaged in any way, such as a power-supply cord or plug is damaged, liquid has been spilled or objects have fallen into the apparatus, the apparatus has been exposed to rain or moisture, does not operate normally, or has been dropped.

Power Source Warning

A label on this product indicates the correct power source for this product. Operate this product only from an electrical outlet with the voltage and frequency indicated on the product label. If you are uncertain of the type of power supply to your home or business, consult your service provider or your local power company.

The AC inlet on the unit must remain accessible and operable at all times.

Ground the Product



WARNING: Avoid electric shock and fire hazard! If this product connects to coaxial cable wiring, be sure the cable system is grounded (earthed). Grounding provides some protection against voltage surges and built-up static charges.

Protect the Product from Lightning

In addition to disconnecting the AC power from the wall outlet, disconnect the signal inputs.

Verify the Power Source from the On/Off Power Light

When the on/off power light is not illuminated, the apparatus may still be connected to the power source. The light may go out when the apparatus is turned off, regardless of whether it is still plugged into an AC power source.

Eliminate AC Mains Overloads



WARNING: Avoid electric shock and fire hazard! Do not overload AC mains, outlets, extension cords, or integral convenience receptacles. For products that require battery power or other power sources to operate them, refer to the operating instructions for those products.

IMPORTANT SAFETY INSTRUCTIONS, continued

Provide Ventilation and Select a Location

- Remove all packaging material before applying power to the product.
- Do not place this apparatus on a bed, sofa, rug, or similar surface.
- Do not place this apparatus on an unstable surface.
- Do not install this apparatus in an enclosure, such as a bookcase or rack, unless the installation provides proper ventilation.
- Do not place entertainment devices (such as VCRs or DVDs), lamps, books, vases with liquids, or other objects on top of this product.
- Do not block ventilation openings.

Protect from Exposure to Moisture and Foreign Objects



WARNING: Avoid electric shock and fire hazard! Do not expose this product to liquids, rain, or moisture.



WARNING: Avoid electric shock and fire hazard! Unplug this product before cleaning. Do not use a liquid cleaner or an aerosol cleaner. Do not use a magnetic/static cleaning device (dust remover) to clean this product.



WARNING: Avoid electric shock and fire hazard! Never push objects through the openings in this product. Foreign objects can cause electrical shorts that can result in electric shock or fire.

Service Warnings



WARNING: Avoid electric shock! Do not open the cover of this product. Opening or removing the cover may expose you to dangerous voltages. If you open the cover, your warranty will be void. This product contains no user-serviceable parts.

Check Product Safety

Upon completion of any service or repairs to this product, the service technician must perform safety checks to determine that this product is in proper operating condition.

Protect the Product When Moving It

Always disconnect the power source when moving the apparatus or connecting or disconnecting cables.

20080513_UL60065 for IP_US/Canada

Change the Way You Watch TV

Welcome to Internet Protocol Television (IPTV). The Cisco® CIS430 High-Definition IPTV Set-Top with DVR brings a new set of services directly to you through your TV and your in-home IP network. The set-top uses existing in-home network wiring and connects to most all entertainment devices.

Available services may include some or all of the following features:

- Digital Video Recorder (DVR) enables you to record your favorite programs while you go out to dinner. You do not have to miss your favorite TV show
- Pause Live TV allows you to pay for the pizza and come back to your show
- High-Definition (HD) Video provides clearer pictures and sound when compared to standard-definition — you won't want to watch television any other way once you've experienced HD
- Video-On-Demand (VOD) gives you access to a large library of movies and shows that you can watch — when you want to watch them

Note: Your set-top may not support all of the above services. Contact your service provider to find out if HD or VOD services are available and to activate the services.

Follow the instructions in this guide to install the set-top, to become familiar with the buttons on the front panel, and to access your programming services. Then, enjoy the features of the set-top and change the way you watch TV.

Safety First

Before using the set-top, read the Important Safety Instructions section of this guide.

Serial Number

At times, your service provider may ask for the serial number. To find the serial number for your set-top, look on the bottom for a label. The serial number is a 9-digit numeric code to the right of the letters "SN" on the label.

Use the space provided here to record the serial number:

In This Manual

This manual provides the information you need to connect your set-top to the in-home network and to your entertainment devices. If you are new to the world of high-definition TV (HDTV), we provide detailed information on HDTV, picture formats, and troubleshooting at the end of this manual.

Front Panel Features

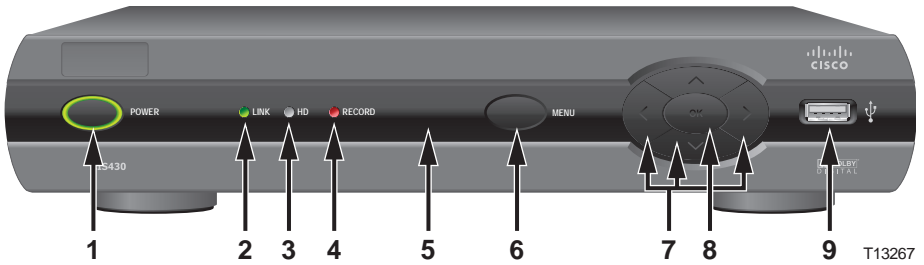

- 1 Power** Turns the set-top on or places it in standby mode. The LED is green
- 2 Link** Indicates network link status. The LED is green
- 3 HD** Indicates that a high-definition program is in progress. The LED is blue
- 4 Record** Indicates that a recording is in progress. The LED is red
- 5 IR Sensor** Receives the infrared signal from the remote control. The sensor is behind the front panel
- 6 Menu** Accesses the on-screen menu
- 7 Arrow Keys** Accesses on-screen services (such as the on-screen guide, video-on-demand, or pay-per-view) and navigates menus
- 8 OK** Selects the current item
- 9 USB Port** USB connector



CAUTION:

Avoid damage to the product.

Always wait at least 10 seconds after powering down the set-top for the DVR drive head to spin down (stop) before moving or handling the DVR.

Your set-top contains a sophisticated hard disk drive that is designed to record and stream digital video. You must not mishandle this DVR product. Handle this product with the same level of care you would use when handling other electronics containing a hard disk drive, such as computers.

Back Panel Connectors

Note: Image may vary from actual product

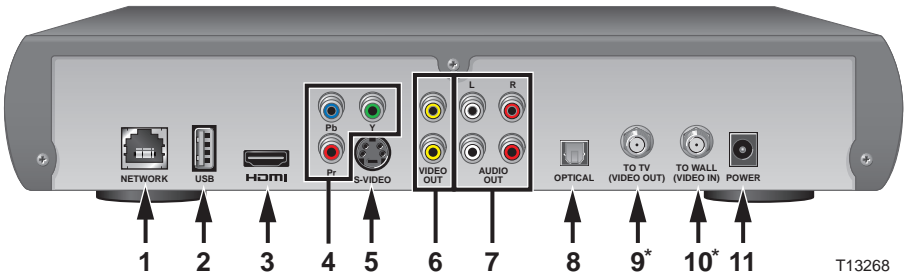

T13268

- 1 Network** Connect to the Ethernet (CAT-5) network in your home, if applicable
- 2 USB Port** USB connector
- 3 HDMI** Connect an HDTV HDMI™ (High-Definition Multimedia Interface) cable from the HDTV to the HDMI port. HDMI supports both digital audio and video
- 4 YPbPr** Connect the set-top to the component video input (YPbPr) on the HDTV
- 5 S-Video** Connect an S-Video cable to send an S-Video signal to your TV or VCR. This signal is standard definition but higher quality than other SDTV connections
- 6 Video Out** Connect to either a VCR or connect to another set of inputs (composite) on your HDTV or SDTV
Note: Two video output connectors are provided. Typically, one output is connected to the TV, and the other output is used to connect to a home theater system, DVD recorder, or VCR
- 7 Audio Out (L/R)** Connect RCA-type cables to Audio Out to send analog audio signals (left and right) to a TV with stereo inputs or to a stereo amplifier
Note: Two sets of audio out connectors are provided. Typically, one set of outputs is connected to the TV, and the other set is used to connect to a home theater system, DVD recorder, or VCR
- 8 Optical** Connect an optical cable to send a digital audio signal to a surround-sound receiver or other digital audio device
- 9 To TV* (Video Out)** Connect to TV. This is a channel 3/4 output. You must set the channel on your TV to the correct channel (either channel 3 or 4)
- 10 To Wall* (Video In)** Connect the set-top to in-house coaxial wiring, if applicable. This signal is used to receive an Ethernet-over-coaxial signal.
- 11 Power** Connect the DC output of the AC power adapter (provided) to deliver power to the set-top

* May not be available on all models.

Connecting Your Set-Top

To connect your set-top to your network and home entertainment devices, complete these steps.



Because the connections for a high-definition (HD) or standard-definition (SD) TV are different, you must determine if your TV is HD or SD. Your TV must receive HD signals for you to enjoy the benefits of HDTV. Refer to the manual that came with your TV for more information. **See page 23** for more information on picture formats.



or



Make one of the following connections to your home network:

- If your home network uses coaxial cable, use the TO WALL connector on the set-top.
- If your home network uses twisted pair cable (phone line wiring), use the TO WALL connector on the set-top and an adapter that converts twisted pair to coaxial cable.
- If your home network uses Ethernet (CAT-5) cable, use the NETWORK connector on the set-top.

Note: **See page 10** for examples.



Make the connections for your TV and/or VCR as follows:

- If you are using an HDTV, **see page 11** and the connection diagrams in this guide.
- If you are using an SDTV, **see page 12** and the connection diagrams in this guide.
- If you want to archive some programs to VCR tape or recordable DVD, **see page 13** and the connection diagrams in this guide.



Identify the additional devices you will connect to the set-top and TV. **See pages 14 through 21** and the related user's guides for more information.

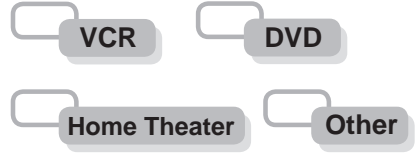

Plug the set-top and the TV into an AC power source that is not controlled by a switch.

For further instructions on completing your setup, refer to the IP device user guide available from your service provider.

Connecting to the Home Network

The following diagrams illustrate examples of the connections you can use to connect your set-top to your in-home network. Contact your service provider for the recommended connection method for your home.

Note: The in-home coaxial and phonenumber wiring networks use HomePNA™ 3.1 technology

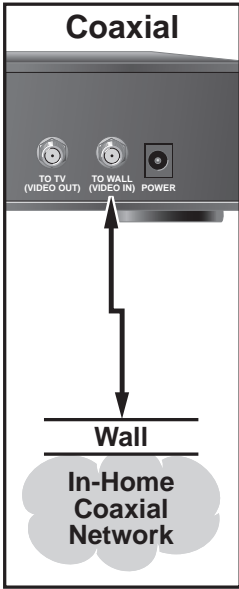

OR

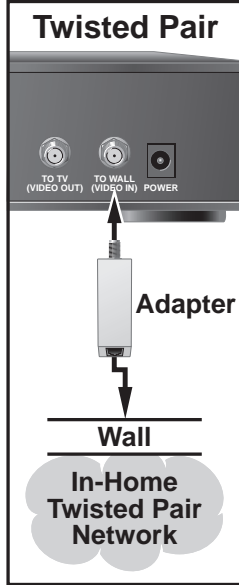

OR

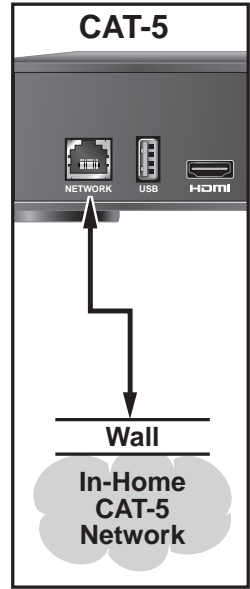







T13211

Connections for an HDTV

To use the set-top with an HDTV, you must make *one* of the following connections to view the HD content. Refer to your TV user guide and the cabling diagrams in this guide for more detailed connection information.

Notes:

- The labeling on your set-top or HDTV may vary slightly.
- Some cables shown in the connection diagrams may not be included with this set-top.









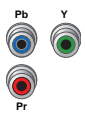

Required Connections to an HDTV (use one)		Set-Top Connections		HDTV Connections
HDMI	<p>The HDMI connector provides both a digital video and audio connection. See the connection diagram on page 14 for an example.</p> <p>Note: The HDMI port on the TV must support high-bandwidth digital content protection (HDCP).</p>	 <p>HDMI</p>	Audio/Video	 <p>HDMI</p>
YPbPr	<p>The YPbPr connectors provides high-definition component video signals to an HDTV.</p> <p>Note: Set the HD mode and select the output video format (480i, 480p, 720p, 1080i) on the set-top that matches the full capabilities of your HDTV.</p> <p>See the connection diagram on page 16 for an example.</p>		Video	
RGB	<p>Some HDTVs have only RGB or RGB-HV connectors. If you have one of these HDTVs, you need an RGB adapter. Check with your service provider for information about acquiring an RGB adapter, or you can purchase the adapter at your local electronics supplier.</p>	 <p>Adapter Needed</p>	Video	

Connections for an SDTV

When using the set-top with an SDTV, you must make *one* of the following connections to view content. Some SDTVs may not have all these connections. Refer to your TV user guides and the cabling diagrams in this guide for more detailed information.

Notes:

- The labeling on your set-top or SDTV may vary slightly.
- Some cables shown in the connection diagrams may not be included with this set-top.







Required Connections to an SDTV (use one)		Set-Top Connections		HDTV Connections
YPbPr	<p>The YPbPr connectors provide standard-definition component video signals to an SDTV.</p> <p>Note: To connect YPbPr to an SDTV, you must set the set-top to an output video format that matches the capabilities of your HDTV (typically only 480i).</p> <p>See the connection diagram on page 19 for an example.</p>		Video	
				Audio
S-Video	<p>The S-Video Out connection provides an optimal video connection to SDTVs. A separate audio connection is also needed.</p>		Video	
				Audio
Video Out	<p>The Video Out connector provides a video connection to an SDTV. A separate audio connection is also needed.</p>		Video	
				Audio
To TV (Video Out)	<p>The To TV (Video Out) connector provides a video and audio connection to an SDTV. You must set the channel on your TV to either channel 3 or channel 4.</p>		Audio/Video	

Connections for a VCR or DVD Recorder

When using the receiver with a VCR or DVD recorder, you must make one of the following connections to view content.

Notes:

- The labeling on your set-top, VCR, or DVD Recorder may vary slightly.
- Some cables shown in the connection diagrams may not be included with this set-top.

	Optional Connections to a VCR or DVD Recorder (use one)	Set-Top Connections		HDTV Connections
S-Video	For VCRs with S-Video and Left and Right audio connectors, you can use the S-Video Out and the Audio Out Left and Right connectors on the set-top.	 <p>S-VIDEO</p>	Video	 <p>S-VIDEO IN</p>
		 <p>AUDIO OUT L R</p>		Audio
Video Out	For VCRs or DVD Recorders with Video and Left and Right audio connectors, you can use the Video Out and the Audio Out connectors (Left and Right) on the set-top. See the connection diagram on page 18 for an example.	 <p>VIDEO OUT</p>	Video	 <p>VIDEO IN</p>
		 <p>AUDIO OUT L R</p>		Audio

Connecting to an HDTV with an HDMI Connector

Cable Used in this Configuration

- 1 HDMI-to-HDMI Cable

Note: The HDMI port on the TV must support high-bandwidth digital content protection (HDCP).



WARNING:

Electric shock hazard! Unplug all electronic devices before connecting or disconnecting any device cables to the set-top.

CIS430 DVR

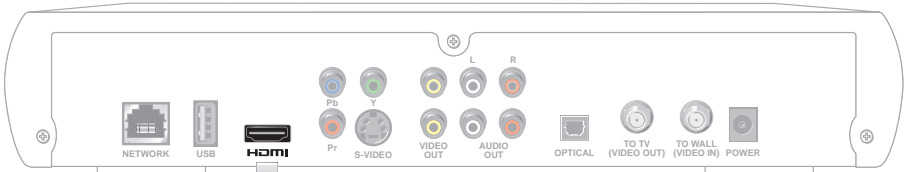

Back of HDTV

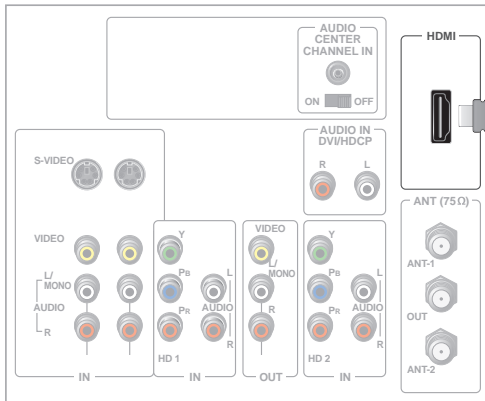

T13222

Note: Image may vary from actual product.

Connecting to an HDTV with a DVI Connector

Cables Used in this Configuration

- 1 HDMI-to-DVI Cable or 1 HDMI-to-HDMI Cable and 1 HDMI-to-DVI Adapter
- 1 Set Audio Left/Right Cables

Tips:

- The DVI port on the TV must support high-bandwidth digital content protection (HDCP).
- When you connect the HDMI connector to the DVI connector on your HDTV, you need an HDMI-to-DVI adapter, and you need a separate audio connection.



WARNING:

Electric shock hazard! Unplug all electronic devices before connecting or disconnecting any device cables to the set-top.

CIS430 DVR

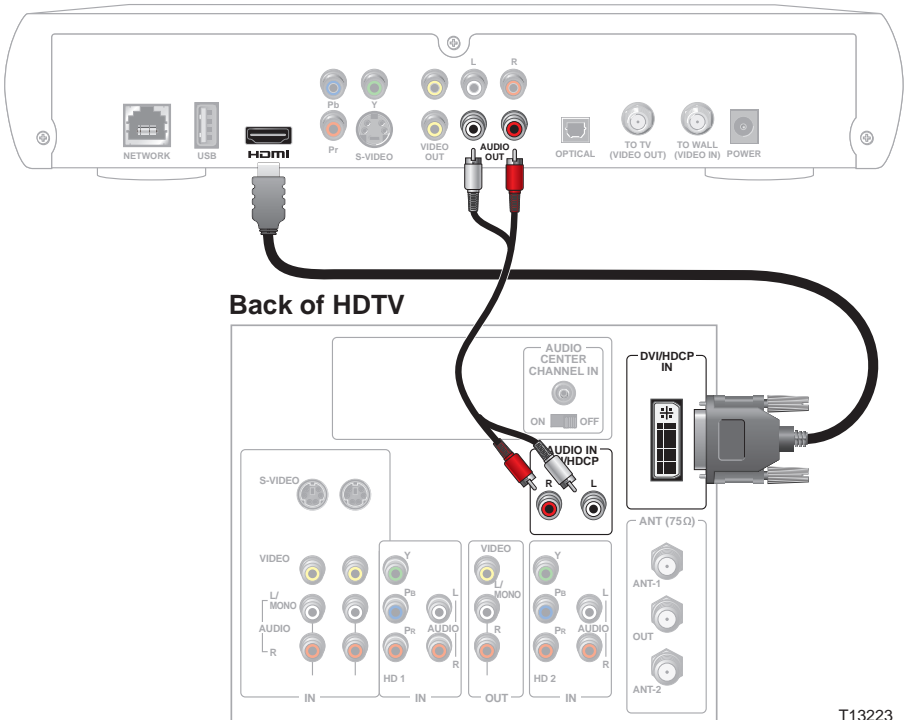

T13223

Note: Image may vary from actual product.

Connecting to an HDTV with Component (YPbPr) Connectors

Cables Used in this Configuration

- 1 Set Component Video Cables (YPbPr)
- 1 Set Audio Left/Right Cables



WARNING:

Electric shock hazard! Unplug all electronic devices before connecting or disconnecting any device cables to the set-top.

CIS430 DVR

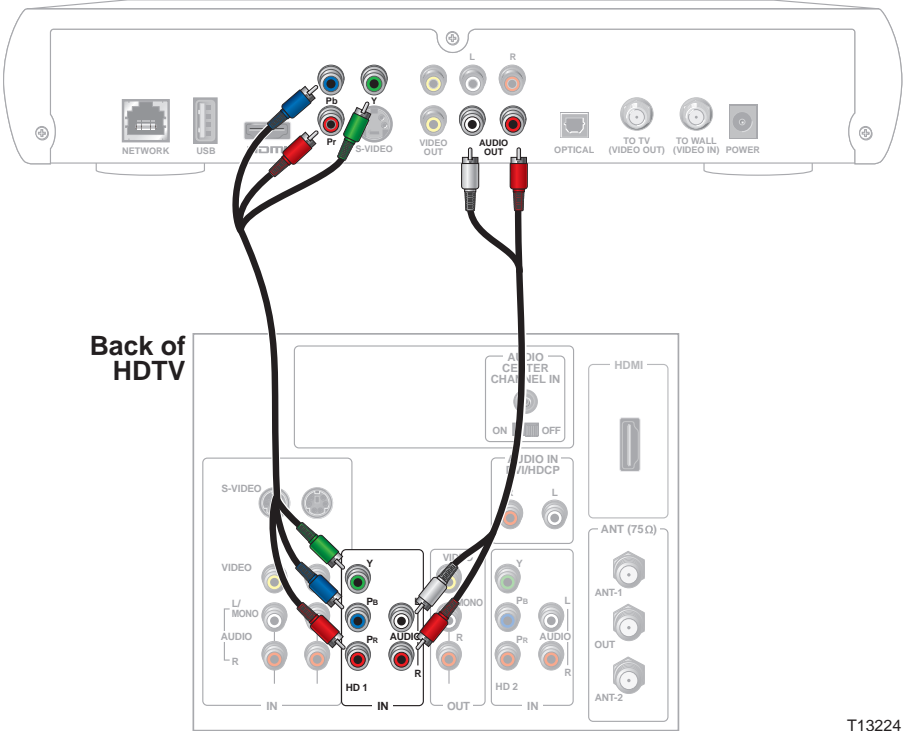

T13224

Note: Image may vary from actual product.

Connecting to a Home Theater System with Component (YPbPr) Connectors

Cables Used in this Configuration

- 3 Sets Component Video Cables (YPbPr)
- 2 Sets Audio Left/Right Cables (you can also use optical cables instead of the Audio Left/Right Cables as shown in the diagram, indicated by dotted lines)
- 1 RCA-type Video Cable

Note: This connection assumes that audio is provided by the home theater speakers.

CIS430 DVR

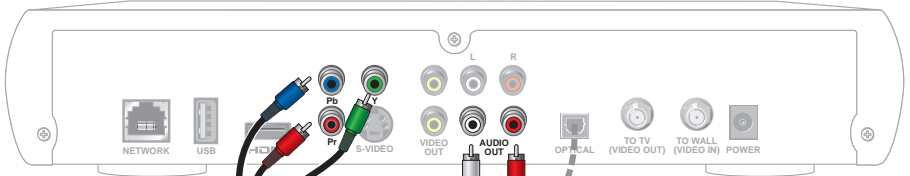

Note: Image may vary from actual product.



WARNING:

Electric shock hazard!
Unplug all electronic devices before connecting or disconnecting any device cables to the set-top.

OR

Back of Home Theater Receiver

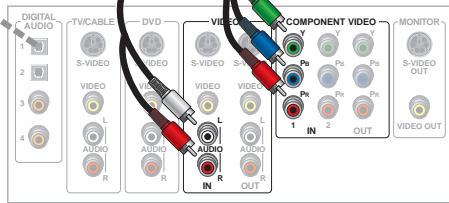

Back of Home Theater Receiver

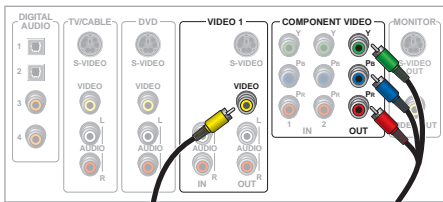

Back of Home Theater Receiver

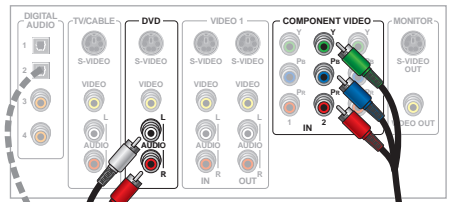

Back of HDTV

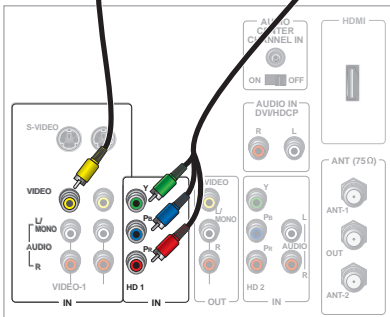

OR

Back of DVD Player

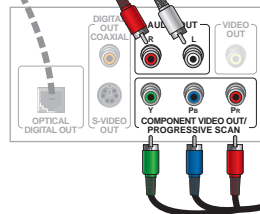

Connecting to a Stereo VCR or DVD Recorder (optional)

This connection, in addition to some other connections to the TV, allows you to record and play back programming on your VCR.

Cables Used in this Configuration

- 1 RCA-type Video Cable
- 1 Set Audio Left/Right Cables

Note: This connection does not provide an HD signal to the TV. You must use one of the video connections shown on pages 14-16 or page 19 in addition to this connection to obtain an HD signal to the TV.



WARNING:

Electric shock hazard! Unplug all electronic devices before connecting or disconnecting any device cables to the set-top.

Connecting your TV directly to the Audio/Video output of your set-top will assure a more vivid picture and enhance your viewing enjoyment.

CIS430 DVR

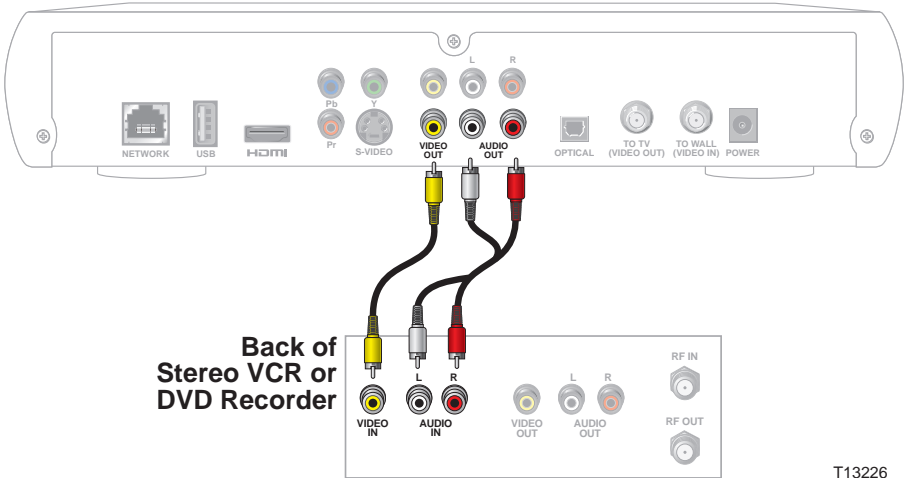

T13226

Note: Image may vary from actual product.

Connecting to an SDTV with Component (YPbPr) Connectors

Cables Used in this Configuration

- 1 Component Video Cable (YPbPr)
- 1 Set Audio Left/Right Cables

Note: The set-top must be set to the proper output mode, typically 480i or 480p.



WARNING:

Electric shock hazard! Unplug all electronic devices before connecting or disconnecting any device cables to the set-top.

CIS430 DVR

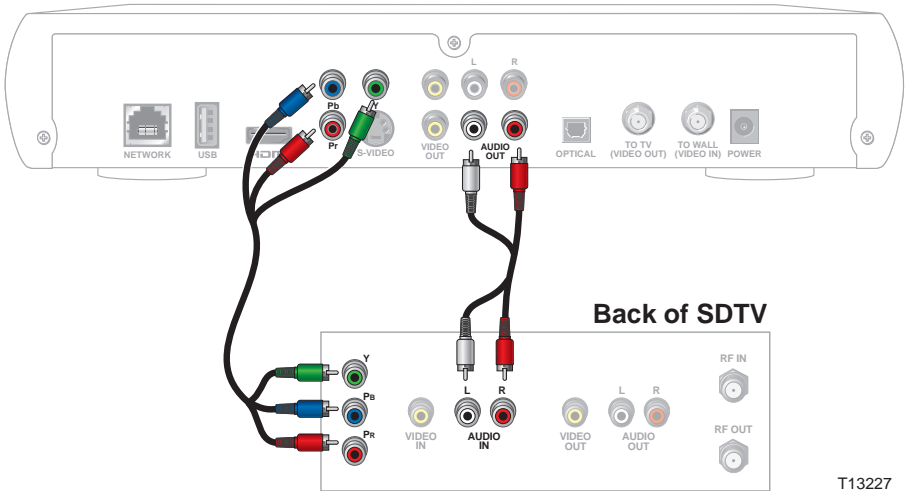

T13227

Note: Image may vary from actual product.

Connecting to an SDTV with an RCA-Type Connector

Cables Used in this Configuration

- 1 RCA-type Video Cable
- 1 Set Audio Left/Right Cables



WARNING:

Electric shock hazard! Unplug all electronic devices before connecting or disconnecting any device cables to the set-top.

CIS430 DVR

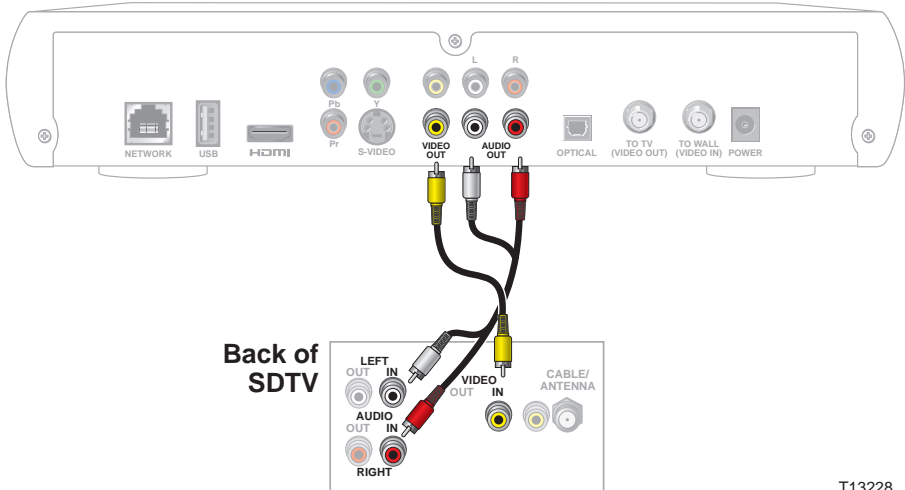

T13228

Note: Image may vary from actual product.

Connecting to an SDTV with a Coaxial Cable

Cable Used in this Configuration

- 1 Coaxial cable with standard F connectors

Note: You must set the channel on your TV to the correct channel (either channel 3 or channel 4). Contact your service provider for the channel information.



WARNING:

Electric shock hazard! Unplug all electronic devices before connecting or disconnecting any device cables to the set-top.

CIS430 DVR

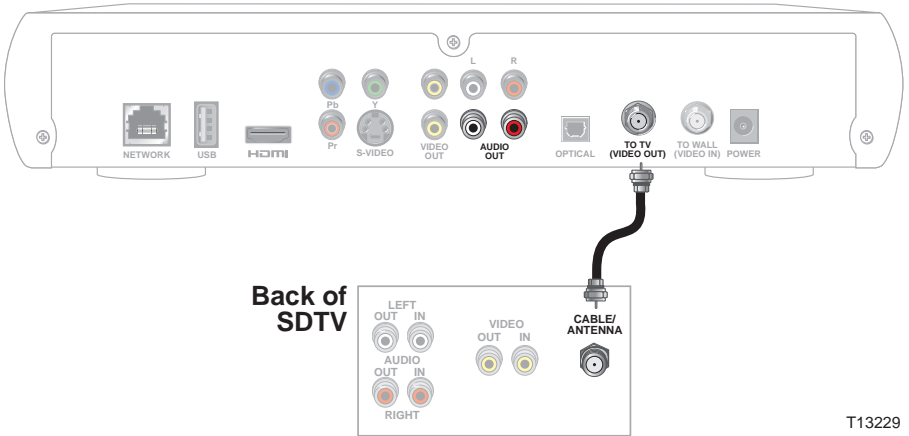

T13229

Note: Image may vary from actual product.

Troubleshooting

If the set-top does not perform as expected, the following tips may help. If you need further assistance, contact your service provider.

No Picture

- Verify that the power to your TV is turned on and the Link light is lit.
- If the set-top is plugged into a wall switch, verify that the switch is in the ON position.
- Verify that all cables are properly connected.
- If your system includes a VCR or stereo, verify that you have properly connected them to the set-top.
- Verify the proper input selection to the home theater receiver or TV.
- Verify that the set-top is set to the proper screen type and resolution.
- If you are using coaxial cable to connect to your TV, verify that the TV is tuned to the correct channel.

No Color or Incorrect Color

- Verify that the current TV program is broadcast in color.
- Adjust the TV color controls.
- If you are using a component video connection (YPbPr), check that all connectors are completely and properly plugged into the set-top and TV.
- If you are using a component video connection (YPbPr) and your HDTV only has RGB or RGB-HV connectors, you must use an adapter. Contact your service provider for more information.

No Sound

- If your setup includes a VCR or stereo, verify that you have properly connected them to the set-top.
- Verify that the volume is turned up.
- Verify that the mute function is not on.
- Verify the proper input selection to the home theater receiver or TV.
- If you are using coaxial cable to connect to your TV, verify that the TV is tuned to the correct channel.

Avoiding Screen Burn-In

Images such as letterbox bars or side bars, bright closed-captioning backgrounds, station logos, or any other stationary images may cause the display in your HDTV to age unevenly; this is known as screen burn-in. Refer to the user's guide that came with your HDTV for more information.



CAUTION:

Avoid screen burn-in. Do not display the same fixed images on your HDTV screen for extended periods of time.

Frequently Asked Questions

What Is Digital Television?

Digital television (DTV) is a huge leap forward in television technology compared to analog television that has been widely available since the 1940s. DTV is delivered and displayed using digital encoding, similar to the way a PC operates. By using digital technology, there is no variation in picture and sound quality from the origination point until it is displayed on your television. You always receive a high-quality picture without the wavy lines or static you might sometimes get from a weak analog signal. Another feature of digital television is digital surround sound using Dolby™ Digital technology, which is the same technology used to produce the sound you hear in movie theaters.

What Is Standard-Definition Television?

Standard-definition television (SDTV) is basic digital television programming delivered by your service provider. Typically, the SDTV screen is the same, nearly square shape as an analog television screen. Digital images on an SDTV set are crisp and clear—noticeably better than on a standard analog television set using an antenna to receive over-the-air signals.

What Is High-Definition Television?

High-definition television (HDTV) is a completely new way to send and receive television broadcast signals. HDTV images are made up of pixels that are much smaller and closer together than those used in standard analog television, and there are millions of them. Thus, HDTV can display five to six times the detail of analog television to deliver picture quality that is much more realistic, dimensional, and precise. SDTV programs can be viewed on an HDTV.

Are Local TV Stations or Other Programmers Broadcasting in HDTV?

Many local TV stations and programmers are transmitting digital signals. However, transmitting a digital signal does not mean transmitting an HDTV signal. Some stations are using the new bandwidth to broadcast several standard-definition channels. Most stations and programmers, once they begin broadcasting in digital, are offering HD content from their parent network (for example, CBS, ABC, NBC, CW, UPN, and PBS). Contact your service provider for more information.

Why Aren't All the Shows I Watch in High-Definition?

A high-definition program must originate in HD format and be broadcast in HD format. Having an HDTV system does not mean that everything you watch will be viewed in high-definition. Getting the signal from a digital source also does not mean it is high-definition.

Why Are Some HDTVs 4:3 Aspect Ratio and Others 16:9?

The aspect ratios differ because television manufacturers build both standard-screen and wide-screen HDTVs to appeal to consumer viewing preferences. The two aspect ratios are as follows:

- On standard-screen (4:3) HDTVs, the programming is displayed in letterbox format in the middle of the screen. There are bars surrounding the picture.
- On wide-screen (16:9) HDTVs, the programming is displayed on the full screen.

Picture Formats

What Is the Difference Between a Standard-Screen and a Wide-Screen HDTV?

The type of screen your HDTV has (wide-screen or standard-screen) determines how the set-top displays programs on the screen. The picture format for an HDTV is a combination of *aspect ratio* and *screen resolution* and is different for standard-screen and wide-screen HDTVs.

What Is Aspect Ratio?

An aspect ratio is the ratio of the width to the height of the TV screen. The aspect ratios differ because the television industry manufactures both standard-screen and wide-screen HDTVs to appeal to consumer viewing preferences.

What Is the Screen Resolution?

The screen resolution indicates the amount of detail that the picture displays. Resolution is identified by the number of display lines on the screen. The techniques that an HDTV uses to “paint” the picture on the screen are referred to as progressive and interlaced.

With the **progressive method**, every pixel on the screen is refreshed simultaneously. The **interlace method** involves refreshing pixels in alternation — first the odd lines and then the even lines.

For advance setup, select the scan modes that your TV can support. Refer to your HDTV user’s guide to choose the proper scan rates (480i, 480p, 720p, 1080i) for your setup.

For example, a resolution of 1080i indicates that the screen shows 1080 lines in an interlaced display, and 720p indicates that the screens shows 720 lines in a progressive display.

Note: The screen resolution is sometimes referred to as the scan rate. The terms are interchangeable.

A **standard-screen HDTV** has a 4x3 aspect ratio. The screen is 4 units wide for every 3 units tall.

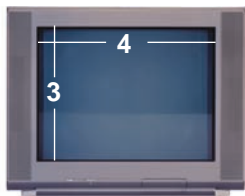

A screen resolution of 480i fills the screen.

A **wide-screen HDTV** is one-third wider than a standard-screen HDTV. The screen is 16 units wide for every 9 units tall.



A screen resolution of 720p or 1080i fills the screen.

Index

A

- AC Power input 8
- Arrow keys 7
- Aspect ratio 23, 24
- Audio Out 8, 11, 12

B

- Back panel 8
- Burn-in of screen 22
- Buttons. *See* Front panel

C

- Cables 9, 10, 13-21
- CAT-5 9, 10
- Coaxial Cable Input 8, 9, 10, 21
- Coaxial network connection 10
- Compliance, FCC 27
- Component video connection. *See* YPbPr
- Connectors

See also Front panel; Back panel

- required for HDTV 11
- required for SDTV 12
- VCR 13, 18

Connecting the set-top to other devices

- Component input YPbPr) 11, 12, 16, 17, 19
- DVI connector 11, 15
- DVD recorder 13, 17
- HDMI connector 11, 14
- Home Theater System with component input (YPbPr) 17
- SDTV 12, 19, 20, 21
- S-Video 12
- VCR 13, 17

Connection

- Home Network 10
- Set-Top 9

Controls. *See* Front panel

D

- Diagrams. *See* Connecting the set-top to other devices
- Digital TV, What is it 23
- DVI connector 11, 15

E

- Ethernet network 8, 9, 10

F

- FAQs 23
- FCC compliance 27
- Formats, picture 24
- Frequently Asked Questions. *See* FAQs
- Front panel 7

H

- HD
 - format 23-24
 - HDTV broadcasting 23
 - HDTV, What is it 23
 - indicator 7
- HDMI 8, 11, 14, 15
- High-definition. *See* HD
- Home theater system connection 17

I

- Interlaced scan rate 24
- IR sensor 7

K

Keys. *See* Front panel

N

- Network 9, 10

O

- Optical Audio Output 8, 17

Index, continued

P

- Picture formats 23-24
- Ports. See Connectors
- Power 7, 8
- Programs, view 22, 23, 24
- Progressive scan rate 24

R

- RGB connector 11

S

- S-Video 8, 12
- S-Video In 12
- Safety 2, 4-5
- Scan rates 24
- Screen
 - burn-in 22
 - resolution 24
 - size 23-24
- SD
 - Mode 9, 12, 23
 - TV, What is it 23
- Serial number, locating 6
- Sound, troubleshooting 22
- Standard-definition TV, What is it 23
- Standard-screen TV 23-24

T

- To Wall (Video In) connector 8, 10
- To TV (Video Out) connector 8, 12, 20
- Troubleshooting 22
- TV
 - digital, what is it 23
 - formats 9, 24
 - HDTV, what is it 23
 - programming 23
 - resolution 23-24
 - screen size. See aspect ratio
 - standard-screen 23-24
 - standard-definition, what is it 23
 - wide-screen 23-24

U

- USB port 7, 8

V

- VCR connection 13, 18
- Video In See To Wall
- Video Out See To TV
- View programs 21-24

W

- Watch TV 22
- Wide-screen TV 23-24

Y

- YPbPr
 - connector 8, 11, 12
 - HDTV connection 11, 16, 17
 - home theater connection 17
 - SDTV connection 12, 19-21

Compliance Information

United States FCC Compliance

This device has been tested and found to comply with the limits for a Class B digital device, pursuant to part 15 of the FCC Rules. These limits are designed to provide reasonable protection against such interference in a residential installation. This equipment generates, uses, and can radiate radio frequency energy. If not installed and used in accordance with the instructions, it may cause harmful interference to radio communications. However, there is no guarantee that interference will not occur in a particular installation. If this equipment does cause harmful interference to radio or television reception, which can be determined by turning the equipment OFF and ON, the user is encouraged to try to correct the interference by one or more of the following measures:

- Reorient or relocate the receiving antenna, if applicable.
- Increase the separation between the equipment and receiver.
- Connect the equipment into an outlet on a circuit different from that to which the receiver is connected.
- Consult the cable company or an experienced radio/television technician for help.

Any changes or modifications not expressly approved by Scientific-Atlanta, Inc., could void the user's authority to operate the equipment.

The information shown in the FCC Declaration of Conformity paragraph below is a requirement of the FCC and is intended to supply you with information regarding the FCC approval of this device. The phone numbers listed are for FCC-related questions only and not intended for questions regarding the connection or operation for this device. Please contact your cable service provider for any questions you may have regarding the operation or installation of this device.

FCC Declaration of Conformity

This device complies with Part 15 of FCC Rules. Operation is subject to the following two conditions: 1) the device may not cause harmful interference, and 2) the device must accept any interference received, including interference that may cause undesired operation.

CIS430 High-Definition IPTV DVR Set-Top Model CIS430 Scientific-Atlanta, Inc.; 5030 Sugarloaf Parkway; Lawrenceville, Georgia 30044; USA Telephone 770-236-1077
--

Canada EMI Regulation

This Class B digital apparatus complies with Canadian ICES-003.

Cet appareil numérique de la class B est conforme à la norme NMB-003 du Canada.

20060628FDC

AVC VIDEO LICENSE

With respect to each AVC/H.264 product, we are obligated to provide the following notice:

THIS PRODUCT IS LICENSED UNDER THE AVC PATENT PORTFOLIO LICENSE FOR THE PERSONAL AND NON-COMMERCIAL USE OF A CONSUMER TO (i) ENCODE VIDEO IN COMPLIANCE WITH THE AVC STANDARD ("AVC VIDEO") AND/OR (ii) DECODE AVC VIDEO THAT WAS ENCODED BY A CONSUMER ENGAGED IN A PERSONAL AND NON-COMMERCIAL ACTIVITY AND/OR WAS OBTAINED FROM A VIDEO PROVIDER LICENSED TO PROVIDE AVC VIDEO. NO LICENSE IS GRANTED OR SHALL BE IMPLIED FOR ANY OTHER USE. ADDITIONAL INFORMATION MAY BE OBTAINED FROM MPEG LA, L.L.C. SEE [HTTP://WWW.MPEGLA.COM](http://www.mpegla.com).

Accordingly, please be advised that service providers, content providers, and broadcasters are required to obtain a separate use license from MPEG LA prior to any use of AVC/H.264 encoders and/or decoders.

Macrovision Copyright Notice

This product incorporates copyright protection technology that is protected by U.S. patents and other intellectual property rights. Use of this copyright protection technology must be authorized by Macrovision, and is intended for home and other limited viewing uses only unless otherwise authorized by Macrovision. Reverse engineering or disassembly is prohibited.

Trademarks

Cisco, Cisco Systems, the Cisco logo, the Cisco Systems logo, and Scientific Atlanta are registered trademarks or trademarks of Cisco Systems, Inc. and/or its affiliates in the U.S. and certain other countries.

Manufactured under license from Dolby Laboratories. "Dolby" and the double-D symbol are trademarks of Dolby Laboratories.

HDMI, the HDMI logo, and High-Definition Multimedia Interface are trademarks or registered trademarks of HDMI Licensing LLC.

HomePNA is a trademark of HomePNA Alliance.

All other trademarks mentioned in this document are the property of their respective owners.

Publication Disclaimer

Cisco Systems, Inc., assumes no responsibility for errors or omissions that may appear in this publication. We reserve the right to change this publication at any time without notice. This document is not to be construed as conferring by implication, estoppel, or otherwise any license or right under any copyright or patent, whether or not the use of any information in this document employs an invention claimed in any existing or later issued patent.

Copyright

© 2007-2008 Cisco Systems, Inc. All rights reserved.

Information in this publication is subject to change without notice. No part of this publication may be reproduced or transmitted in any form, by photocopy, microfilm, xerography, or any other means, or incorporated into any information retrieval system, electronic or mechanical, for any purpose, without the express permission of Cisco Systems, Inc.



Scientific Atlanta, A Cisco Company

5030 Sugarloaf Parkway, Box 465447
Lawrenceville, GA 30042

678.277.1000

www.scientificatlanta.com

Product and service availability is subject to change without notice.

© 2007-2008 Cisco Systems, Inc. All rights reserved.

June 2008

Part Number 4021073 Rev C