









Cisco Explorer 4640HD, 4642HD, 4650HD, and 4652HD High-Definition Set-Tops



Notice to Installers

The servicing instructions in this notice are for use by qualified service personnel only. To reduce the risk of electric shock, do not perform any servicing other than that contained in the operating instructions, unless you are qualified to do so.

<p>Note to System Installer</p> <p>For this apparatus, the coaxial cable shield/screen shall be grounded as close as practical to the point of entry of the cable into the building. For products sold in the US and Canada, this reminder is provided to call the system installer's attention to Article 820-93 and Article 820-100 of the NEC (or Canadian Electrical Code Part 1), which provides guidelines for proper grounding of the coaxial cable shield.</p>  <p>This symbol is intended to alert you that uninsulated voltage within this product may have sufficient magnitude to cause electric shock. Therefore, it is dangerous to make any kind of contact with any inside part of this product.</p> <p>Ce symbole a pour but d'alerter toute personne qu'un contact avec une pièce interne de ce produit, sous tension et non isolée, pourrait être suffisant pour provoquer un choc électrique. Il est donc dangereux d'être en contact avec toute pièce interne de ce produit.</p>	<table border="1"><tr><td data-bbox="852 367 933 493"></td><td data-bbox="938 367 1088 493"><p>CAUTION RISK OF ELECTRIC SHOCK DO NOT OPEN</p><p>AVIS RISQUE DE CHOC ELECTRIQUE NE PAS OUVRIR</p></td><td data-bbox="1096 367 1177 493"></td></tr></table> <p>CAUTION: To reduce the risk of electric shock, do not remove cover (or back). No user-serviceable parts inside. Refer servicing to qualified service personnel.</p> <p>WARNING TO PREVENT FIRE OR ELECTRIC SHOCK, DO NOT EXPOSE THIS UNIT TO RAIN OR MOISTURE.</p>  <p>This symbol is intended to alert you of the presence of important operating and maintenance (servicing) instructions in the literature accompanying this product.</p> <p>Ce symbole a pour but de vous avertir qu'une documentation importante sur le fonctionnement et l'entretien accompagne ce produit.</p>		<p>CAUTION RISK OF ELECTRIC SHOCK DO NOT OPEN</p> <p>AVIS RISQUE DE CHOC ELECTRIQUE NE PAS OUVRIR</p>	
	<p>CAUTION RISK OF ELECTRIC SHOCK DO NOT OPEN</p> <p>AVIS RISQUE DE CHOC ELECTRIQUE NE PAS OUVRIR</p>			

20080814_Installer820

Contents

IMPORTANT SAFETY INSTRUCTIONS.....	iv
Welcome.....	1
Safety First	1
Identify Your Set-Top	1
What's in the Carton?	2
Additional Equipment You Might Need	2
Front Panel.....	3
Back Panel	4
Connecting the Set-Top	5
Connections for an HDTV and VCR.....	6
Connections for a Standard-Definition TV and VCR	7
View Television Programming	8
Troubleshooting.....	9
Frequently Asked Questions.....	10
Picture Formats	11
Connecting to an HDTV with an HDMI Connector	12
Connecting to an HDTV with a DVI Connector.....	13
Connecting to an HDTV with Component Input (YPbPr).....	14
Connecting to a Home Theater System with Component Input (YPbPr).....	15
Connecting to a Stereo VCR and HDTV (optional)	16
Connecting to an HDTV with a 1394 Connector.....	17
Connecting the Set-Top in HD Mode to an SDTV with Component Input (YPbPr)	17
Index.....	18
Compliance Information.....	20

IMPORTANT SAFETY INSTRUCTIONS

- 1) Read these instructions.
- 2) Keep these instructions.
- 3) Heed all warnings.
- 4) Follow all instructions.
- 5) Do not use this apparatus near water.
- 6) Clean only with dry cloth.
- 7) Do not block any ventilation openings. Install in accordance with the manufacturer's instructions.
- 8) Do not install near any heat sources such as radiators, heat registers, stoves, or other apparatus (including amplifiers) that produce heat.
- 9) Do not defeat the safety purpose of the polarized or grounding-type plug. A polarized plug has two blades with one wider than the other. A grounding-type plug has two blades and a third grounding prong. The wide blade or the third prong are provided for your safety. If the provided plug does not fit into your outlet, consult an electrician for replacement of the obsolete outlet.
- 10) Protect the power cord from being walked on or pinched particularly at plugs, convenience receptacles, and the point where they exit from the apparatus.
- 11) Only use attachments/accessories specified by the manufacturer.
- 12)  Use only with the cart, stand, tripod, bracket, or table specified by manufacturer, or sold with the apparatus. When a cart is used, use caution when moving the cart/apparatus combination to avoid injury from tip-over.
- 13) Unplug this apparatus during lightning storms or when unused for long periods of time.
- 14) Refer all servicing to qualified service personnel. Servicing is required when the apparatus has been damaged in any way, such as a power-supply cord or plug is damaged, liquid has been spilled or objects have fallen into the apparatus, the apparatus has been exposed to rain or moisture, does not operate normally, or has been dropped.

Power Source Warning

A label on this product indicates the correct power source for this product. Operate this product only from an electrical outlet with the voltage and frequency indicated on the product label. If you are uncertain of the type of power supply to your home or business, consult your service provider or your local power company.

The AC inlet on the unit must remain accessible and operable at all times.

Ground the Product



WARNING: Avoid electric shock and fire hazard! If this product connects to coaxial cable wiring, be sure the cable system is grounded (earthed). Grounding provides some protection against voltage surges and built-up static charges.

Outdoor Grounding System

If this product connects to an outdoor antenna or cable system, be sure the antenna or cable system is grounded (earthed). This provides some protection against voltage surges and built-up static charges.

Article 810 of the National Electric Code (NEC) ANSI/NFPA No. 70-1990, provides the following information:

- Grounding of the mast and supporting structure
- Grounding the lead-in wire to an antenna discharge unit
- Size of the grounding conductors
- Location of the antenna-discharge unit
- Connection to grounding electrodes
- Requirements for the grounding electrodes (see the following antenna grounding diagram as recommended by NEC ANSI/NFPA 70)



WARNING: Avoid electric shock and fire hazard! Do not locate an outside antenna system in the vicinity of overhead power lines or power circuits. Touching power lines or circuits might be fatal.

Example Of Antenna Grounding

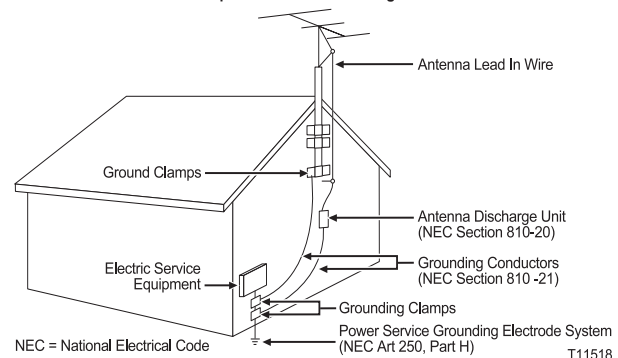

NEC = National Electrical Code

T11518

Protect the Product from Lightning

In addition to disconnecting the AC power from the wall outlet, disconnect the signal inputs.

Verify the Power Source from the On/Off Power Light

When the on/off power light is not illuminated, the apparatus may still be connected to the power source. The light may go out when the apparatus is turned off, regardless of whether it is still plugged into an AC power source.

Eliminate AC Mains Overloads



WARNING: Avoid electric shock and fire hazard! Do not overload AC mains, outlets, extension cords, or integral convenience receptacles. For products that require battery power or other power sources to operate them, refer to the operating instructions for those products.

IMPORTANT SAFETY INSTRUCTIONS, continued

Handling Disposable Batteries

This product may contain disposable batteries. Heed the following warning and follow the Battery Safety and Battery Disposal instructions below.



WARNING: There is danger of explosion if the battery is mishandled or incorrectly replaced. Replace only with the same type of battery. Do not disassemble it or attempt to recharge it outside the system. Do not crush, puncture, dispose of in fire, short the external contacts, or expose to water or other liquids. Dispose of the battery in accordance with local regulations and instructions from your service provider.

Battery Safety

- Insert batteries correctly. There may be a risk of explosion if the batteries are incorrectly inserted.
- Do not attempt to recharge 'disposable' or 'non-reusable' batteries.
- Please follow instructions provided for charging 'rechargeable' batteries.
- Replace batteries with the same or equivalent type that we recommend.
- Do not expose batteries to excessive heat (such as sunlight or fire).
- Do not expose batteries to temperatures above 100°C (212°F).

Battery Disposal

- The batteries may contain substances that could be harmful to the environment.
- Recycle or dispose of batteries in accordance with the battery manufacturer's instructions and local/national disposal and recycling regulations.



廢電池請回收

- The batteries may contain perchlorate, a known hazardous substance, so special handling and disposal of this product might be necessary. For more information about perchlorate and best management practices for perchlorate-containing substance, see www.dtsc.ca.gov/hazardouswaste/perchlorate

Provide Ventilation and Select a Location

- Remove all packaging material before applying power to the product.
- Do not place this apparatus on a bed, sofa, rug, or similar surface.
- Do not place this apparatus on an unstable surface.
- Do not install this apparatus in an enclosure, such as a bookcase or rack, unless the installation provides proper ventilation.
- Do not place entertainment devices (such as VCRs or DVDs), lamps, books, vases with liquids, or other objects on top of this product.
- Do not block ventilation openings.

Protect from Exposure to Moisture and Foreign Objects



WARNING: Avoid electric shock and fire hazard! Do not expose this product to dripping or splashing liquids, rain, or moisture. Objects filled with liquids, such as vases, should not be placed on this apparatus.



WARNING: Avoid electric shock and fire hazard! Unplug this product before cleaning. Do not use a liquid cleaner or an aerosol cleaner. Do not use a magnetic/static cleaning device (dust remover) to clean this product.



WARNING: Avoid electric shock and fire hazard! Never push objects through the openings in this product. Foreign objects can cause electrical shorts that can result in electric shock or fire.

Service Warnings



WARNING: Avoid electric shock! Do not open the cover of this product. Opening or removing the cover may expose you to dangerous voltages. If you open the cover, your warranty will be void. This product contains no user-serviceable parts.

Check Product Safety

Upon completion of any service or repairs to this product, the service technician must perform safety checks to determine that this product is in proper operating condition.

Protect the Product When Moving It

Always disconnect the power source when moving the apparatus or connecting or disconnecting cables.

20090915_Cable_Safety

Welcome

The Cisco® Explorer® High-Definition Set-Tops (set-tops) provide high-definition (HD) capability and broadband digital video services. On MoCA™ enabled set-tops, the MoCA connection enables an IP LAN connection over coaxial cable, which minimizes the need for new wiring in the home.

Follow the instructions in this guide to install the set-top, to become familiar with the buttons on the front panel, and to access your cable services. Then, enjoy the features of the set-top and change the way you watch TV.

The consumer support website provides news and information about this product. For more information, please refer to <http://www.cisco.com/web/consumer/support/index.html>

Safety First

Before using the set-top, read the **Important Safety Instructions** section of this guide.

Identify Your Set-Top

To find the serial number for your set-top, look on the bottom for a label that is similar to the example shown here. The serial number begins with “SA” and is located at the top of the bar code.



If your set-top requires troubleshooting in the future, your cable service provider may ask for this serial number.

Use the space provided here to record the serial number: _____

What's In The Carton?

The set-top carton contains the following items:



• High-Definition Set-Top



• Quick Reference Guide



• HDMI Cable



• Power Cord

Additional Equipment You Might Need

You might need some of the cables and adapters shown below for connecting the set-top to your home entertainment devices. See the connection information in the **Connection Diagrams** section for more information.

Check with your service provider for information about acquiring cables or adapters, or you can purchase cables or adapters at your local electronics supplier.



S-Video Cable



Composite A/V Cables



IR Extender Cable



Audio Left/Right Cable



Component Video Cables (YPbPr)



HDMI Adapter



HDMI-to-DVI Cable



RGB Adapter Cable (RCA to RCA)



RGB Adapter



RF Coaxial Cable



RGB Adapter Cable (RCA to BNC)



Optical Digital Audio Cable



Coaxial Digital Audio Cable



RGB Adapter Cable (RCA to VGA)



IEEE 1394 4-Pin to 4-Pin Cable

Front Panel

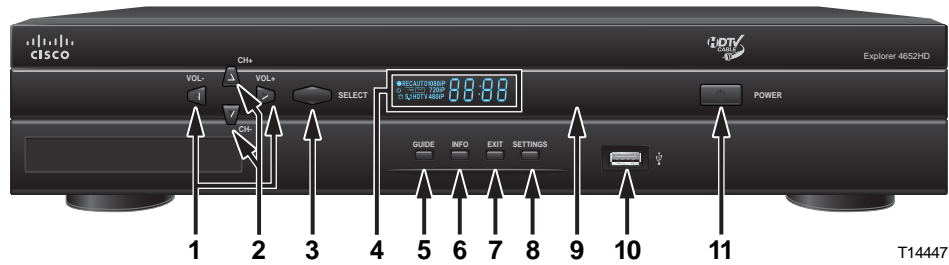

- 1 **VOL +, VOL -** Increases and decreases the volume
- 2 **CH+, CH -** Scrolls up and down through the channels
- 3 **Select** Provides access to your on-screen selection
- 4 **Display** Displays the selected channel number and time of day. The display shows the following:

• Record (●REC)	• Auto	• 1080i / 1080P	• MoCA Link (⚡)
• Power (⏻)	• Message (✉)	• 720i / 720P	• Illuminates when this set-top is connected to a server
• 5.1	• HDTV	• 480i / 480P	
- 5 **Guide** Accesses on-screen services, such as the on-screen guide, video-on-demand, or pay-per-view
- 6 **Info** Displays a description of the selected program. This button is available from the on-screen guide and while viewing a program
- 7 **Exit** Exits menus, the on-screen guide, and program information
- 8 **Settings** Provides access to the Settings menu
- 9 **IR Sensor** Receives the infrared signal from the remote control
- 10 **USB Port** Connects to external equipment, such as a keyboard or mouse (reserved for future use)
- 11 **Power** Turns the set-top on and off

Note: This illustration may vary from the actual product.

Back Panel

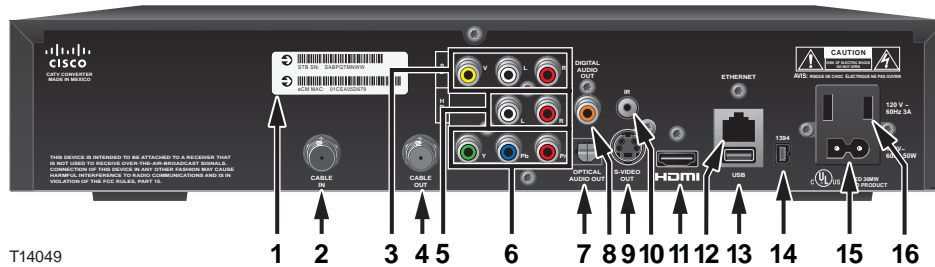

T14049

- 1 Bar Code Label** Contains set-top serial number and MAC address
- 2 Cable In** Connects to a coaxial cable that delivers the signal from your service provider
- 3 Audio/Video Out 2** Connects to either a VCR or to another set of inputs (composite) on your TV
- 4 Cable Out** Connects to a coaxial cable that sends analog audio and video signals to a TV or VCR. These signals are standard-definition TV (SDTV) video and stereo audio
- 5 Audio Out (Left, Right)** Connects to RCA cables that send analog audio signals (left and right) to the stereo inputs on a TV
- 6 HDTV (YPbPr)** Connects to the component video input (YPbPr) on the HDTV, when in HD mode
- 7 Optical Audio Out** Connects to an optical cable that sends a digital audio signal to a surround-sound receiver or other digital audio device
- 8 Digital Audio Out** Connects to an RCA cable that sends a digital audio signal to a surround-sound receiver or other digital audio device
- 9 S-Video Out** Connects to an S-Video cable that sends an S-Video signal to your TV or VCR. This signal is standard definition, but higher quality than other SDTV connections
- 10 IR** Available to be connected to an approved remote IR receiver (purchased separately). Please contact your service provider for details
- 11 HDMI** Connects an HDMI™ cable to the HDMI input of an HDTV. HDMI supports both digital audio and video. May be used to connect to a DVI interface using an HDMI-to-DVI adapter for video and separate audio connections. Any of the following audio connections may be used: Audio Out: Left, Right (5); Optical Audio Output (7); or Digital Audio Out (8)
- 12 Ethernet** Connects to an Ethernet network
- 13 USB** Connects to external USB devices such as a keyboard or a mouse
- 14 1394** Connects to display devices that are equipped with a 1394 input
- 15 AC Power Input** Connects to the power cord to deliver power to the set-top
- 16 AC Outlet** Connects to the AC power cord from another device, such as a TV

Note: This illustration may vary from the actual product.

Connecting the Set-Top

To connect your set-top to your entertainment devices, complete these steps.



Determine if your TV is HD or SD and whether it is wide screen (16:9) or standard screen (4:3). **See page 11** for more information.

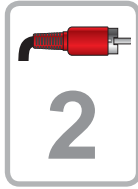

Make the connections for your TV and VCR as follows:

- If you are using an HDTV, **see page 6** and the connection diagrams at the end of this guide.
- If you are using an SDTV, **see page 7** and the connection diagrams at the end of this guide.
- If you want to archive some programs to VCR tape, **see pages 6 and 7** and the connection diagrams at the end of this guide.



Identify the additional devices you will connect to the set-top and TV. **See the Connection Diagrams section** of this guide.

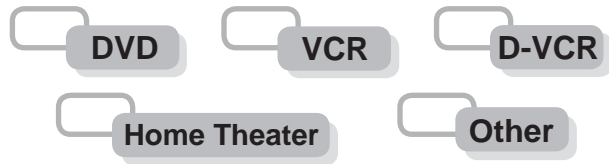

Plug the set-top and the TV into an AC power source that is not controlled by a switch.



Do not turn on the set-top or TV yet.



It may take several minutes for the set-top to receive the latest software, programming, and service information. Wait until you see one of the following displays on the front panel of the set-top that indicates that the update is complete:

- Current time
- Four dashes (- - - -)

Note: If four dashes appear, you must call your service provider to get the set-top authorized.

























































Set up your set-top for HDTV or SDTV by completing the following steps:

- Make sure the set-top is **Off** and the TV is **On**.
- On the front panel of the set-top, press **GUIDE** and **INFO** at the same time. This will activate the HD Setup Wizard.
- Follow the on-screen instructions to choose **HD** or **SD** mode and wide screen (16:9) or standard screen (4:3) depending upon your TV type. **See page 11** for more information on the scan rate.
- At the conclusion of the on-screen instructions, press **POWER** on the set-top to begin watching TV.

Connections for an HDTV and VCR

To use the set-top with an HDTV, you must make *one* of the following connections to view the HD content. In addition, you can make connections to a digital or analog VCR to record to a VCR tape. Refer to your TV and VCR user guides and the cabling diagrams in this guide for more detailed connection information.







Note: The labeling on your set-top, HDTV, and VCR may vary slightly.

Required Connections to an HDTV (use one)		Set-Top Connections	HDTV Connections
HDMI	Some HDTVs have a High-Definition Multimedia Interface (HDMI) connector. The HDMI connector provides both a digital video and audio connection. See the connection diagram on page 12 for an example.		
DVI	The HDMI connector can provide the connection to an HDTV with a DVI input. If your HDTV has a Digital Visual Interface (DVI) connector, you will need an HDMI-to-DVI adapter, and you will need to connect a separate audio connection. See the connection diagram on page 13 for an example.	Adapter Needed  	  
YPbPr	The YPbPr connectors can provide high-definition component video signals to an HDTV. Note: On the front panel of the set-top, press GUIDE and INFO at the same time. This will activate the HD Setup Wizard. Use the HD Setup Wizard on the set-top to set the HD mode and select the output video format that will matches the full capabilities of your HDTV. See the connection diagram on page 14 for an example.	    	    
RGB	Some HDTVs have only RGB connectors. If you have one of these HDTVs, you need an RGB adapter. Check with your service provider for information about acquiring an RGB adapter, or you can purchase the adapter at your local electronics supplier.	Adapter Needed     	      
1394	Some HDTVs have 1394 connectors. If you connect to your HDTV using 1394, you also need to connect separate video and audio connections to your HDTV. See the connection diagram on page 17 for an example.	     	     
Optional Connections to a VCR (use one)		Set-Top Connections	VCR Connections
VCR	For VCRs with Video and Left and Right audio connectors, you can use the Out 2 connectors (Video, Left, and Right) on the set-top. See the connection diagram on page 16 for an example.	  	  
	For VCRs with S-Video and Left and Right audio connectors, you can use the S-Video Out and the Out 2 Left and Right connectors on the set-top.	  	  
	For <i>Digital VCRs</i> , you can use the 1394 out connector on the set-top.		

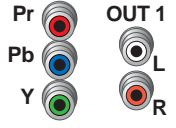
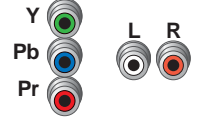
Connections for a Standard-Definition TV and VCR

When using the set-top with an SDTV, you must make *one* of the following connections to view content. Some SDTVs may not have all these connections. In addition, you can make connections to a VCR to record to a VCR tape. Refer to your TV and VCR user guides and the cabling diagrams in this guide for more detailed information.

Note: The labeling on your set-top, SDTV, and VCR may vary slightly.

Required Connections to an SDTV (use one)		Set-Top Connections	SDTV Connections
YPbPr	The YPbPr connectors can provide standard-definition component video signals to an SDTV. Note: To connect YPbPr to an SDTV, you must set the HD Setup Wizard on the set-top to HD Mode , and select the output video format (typically 480i) that will match the capabilities of your SDTV.		
S-Video	The S-Video Out connection provides an optimal video connection to SDTVs.		
Cable Out	The Cable Out connector provides a video and audio connection to an SDTV.		
Optional Connection to a VCR		Set-Top Connections	VCR Connections
VCR	For VCRs with Video and Left and Right audio connectors, you can use the Out 2 connectors (Video, Left, and Right) on the set-top.		

View Television Programming

Access Services and Programs

Access cable services and programs by pressing the following keys on the remote control:

- **Guide**—Access the on-screen guide. The on-screen guide displays schedules of TV programs and other services available from your cable service provider, such as video-on-demand and pay-per-view programs.
- **Arrows**—Select a program in the schedule.
- **Info**—Display a specific program description (either from the on-screen guide or while viewing a program).
- **Select**—View a specific program in the guide.

Stretch and Zoom Program

You can stretch and zoom SD or HD programs by pressing the # key on the remote control.

Avoid Screen Burn-In

Images such as letterbox bars or side bars, bright closed-captioning backgrounds, station logos, or any other stationary images may cause the picture tube in your HDTV to age unevenly; this is known as screen burn-in. Refer to the user's guide that came with your HDTV for more information.



WARNING: Avoid screen burn-in. Do not display the same fixed images on your HDTV screen for extended periods of time.

Troubleshooting

If the set-top does not perform as expected, the following tips may help. If you need further assistance, contact your service provider.

No Picture

- Verify that the power to your TV is turned on.
- Verify that your HDTV is in HD mode. If necessary, run the HD Setup Wizard to select HD mode. On the front panel of the set-top, press **GUIDE** and **INFO** at the same time. This will activate the HD Setup Wizard.
- If the set-top is plugged into a wall switch, verify that the switch is in the ON position.
Note: You should avoid plugging the set-top into an outlet controlled by a wall switch.
- Verify that all cables are properly connected.
- If your system includes a VCR or stereo, verify that you have properly connected them to the set-top.
- Verify that the set-top is set to the proper screen type and resolution.

No Color

- Verify that the current TV program is broadcast in color.
- Adjust the TV color controls.
- If you are using a component video connection (YPbPr), check that all connectors are completely plugged into the set-top and TV.

No Sound

- If your setup includes a VCR or stereo, verify that you have properly connected them to the set-top.
- Verify that the volume is turned up.
- Verify that the mute function is not on.

Automatic Software Updates

A message appears on the TV screen when the set-top is receiving software updates. In addition, download information also appears on the front panel of the set-top during these updates. Wait for the current time to display on the front panel before continuing. When the time appears, the update is complete.

Frequently Asked Questions

What is Digital Television?

Digital television (DTV) is a huge leap forward in television technology compared to analog television that has been widely available since the 1940s. DTV is delivered and displayed using digital encoding, similar to the way a PC operates. By using digital technology, there is no variation in picture and sound quality from the origination point until it is displayed on your television. You always receive a high-quality picture without the wavy lines or static you might sometimes get from a weak analog signal.

Because DTV receives and displays digital images that contain many times more picture elements (pixels - the small dots that make up the color image on your screen) than standard analog television, you can get a sharper on-screen image than with analog. Additionally, DTV supports CD-quality sound. DTV includes SDTV (Standard-Definition Television), EDTV (Enhanced-Definition Television), and HDTV (High-Definition Television). That means that all HDTV is digital, but not all digital TV is high-definition. A high-definition program must originate in HD format and be broadcast in HD format. Having an HDTV system does not mean that everything you watch will be in high-definition. Getting the signal from digital cable also does not mean it is high-definition.

What is Standard-Definition Television?

Standard-definition television (SDTV) is basic digital television programming delivered by cable. Typically, the SDTV screen is the same, nearly square shape as an analog television screen. Digital images on an SDTV set are crisp and clear—noticeably better than on a standard analog television set using an antenna to receive over-the-air signals.

What is High-Definition Television?

High-definition television (HDTV) is a completely new way to send and receive television broadcast signals. HDTV images are made up of pixels that are much smaller and closer together than those used in standard analog television, and there are millions of them. Thus, HDTV can display five to six times the detail of analog television to deliver picture quality that is much more realistic, dimensional, and precise. SDTV programs can be viewed on an HDTV. Another feature of HDTV is digital surround sound using Dolby™ Digital technology, which is the same technology used to produce the sound you hear in movie theaters.

Are Local TV Stations Broadcasting in HDTV?

Many local TV stations are transmitting digital signals. However, transmitting a digital signal does not mean transmitting an HDTV signal. Some stations are using the new bandwidth to broadcast several standard-definition channels. Most stations, once they begin broadcasting in digital, are offering HD content from their parent network (for example, CBS, ABC, NBC, Fox, and PBS).

Where Are the Connection Diagrams?

The diagrams at the end of this guide show examples of common ways to connect the set-top to your HDTV, DVD, and home theater receiver. However, these diagrams do not show every possible combination of devices. Refer to the user's guides that came with your other electronic devices for further information.

What Cables Do I Need?

Some of the cables and adaptors shown in the diagrams may not be included with the set-top. Some of the required cables are shown in the connection diagrams and on page 2 of this guide.

Picture Formats

What is the Difference Between a Standard-Screen and a Wide-Screen HDTV?

The type of screen your HDTV has (wide screen or standard screen) determines how the set-top displays programs on the screen. The picture format for an HDTV is a combination of *aspect ratio* and *screen resolution* and is different for standard-screen and wide-screen HDTVs.

What is Aspect Ratio?

An aspect ratio is the ratio of the width to the height of the TV screen. The aspect ratios differ because the television industry manufactures both standard-screen and wide-screen HDTVs to appeal to consumer viewing preferences.

What is the Screen Resolution and Scan Rate?

The screen resolution indicates the amount of detail that the picture displays. Resolution is identified by the number of display lines on the screen. The techniques that an HDTV uses to “paint” the picture on the screen are referred to as progressive and interlaced.

With the **progressive method**, the lines are drawn on the screen one at a time in sequential order. The **interlaced method** involves refreshing pixels in alternation — first the odd lines and then the even lines.

For advance setup, select the scan modes that your TV can support. Refer to your set-top and HDTV user’s guides to choose the proper scan rates (480i, 480p, 720p, 1080i) for your setup.

For example, a resolution of 1080i indicates that the screen shows 1080 lines in an interlaced display, and 480p indicates that the screens shows 480 lines in a progressive display.

Notes:

- The screen resolution (1080i, 480p, and so forth) is sometimes referred to as the scan rate. The terms are interchangeable.
- You can stretch and zoom the displayed picture using the built-in capability of the set-top by pressing the # key on the remote control.

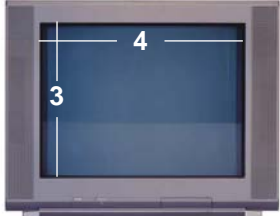
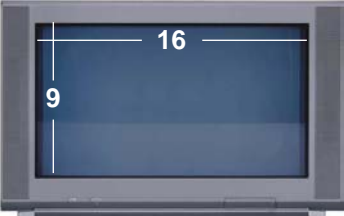
<p>A standard-screen HDTV has a 4x3 aspect ratio. The screen is 4 units wide for every 3 units tall.</p>  <p>A screen resolution of 480p or 480i fills the screen.</p>	<p>A wide-screen HDTV is one-third wider than a standard-screen HDTV. The screen is 16 units wide for every 9 units tall.</p>  <p>A screen resolution of 720p or 1080i fills the screen.</p>
--	---

Connecting to an HDTV with an HDMI Connector



WARNING: Electric shock hazard! Unplug all electronic devices before connecting or disconnecting any device cables to the set-top.

Required cables:

- 1 HDMI cable

Back of Set-Top

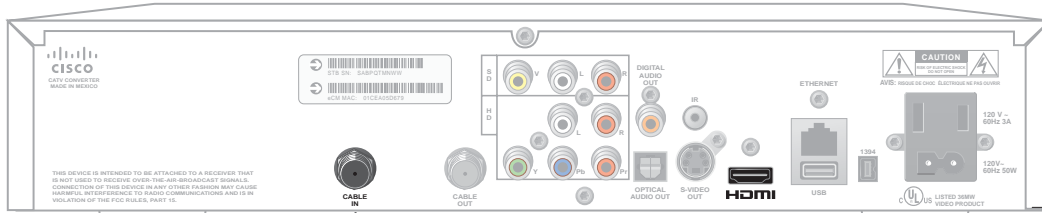

Cable Input

Back of HDTV

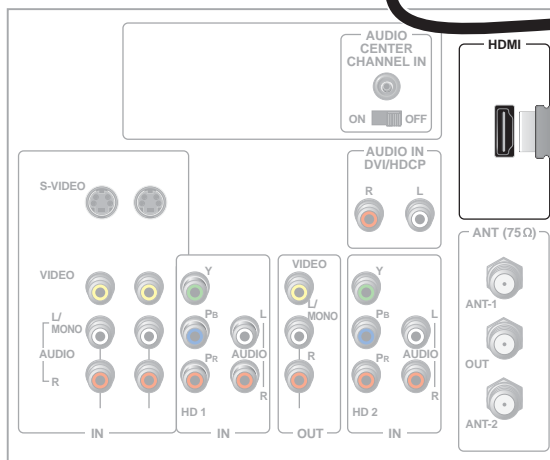

T14448

Important Notes Regarding the HDMI Interface on the Set-Top

The HDMI interface automatically configures the audio output for a format supported by the television. Because not all TVs support the Dolby Digital input, the HDMI interface may automatically select a 2-channel stereo audio configuration instead of Dolby Digital, which it carries over to the other digital audio outputs of the set-top. This prevents your home theater system or Dolby Digital decoder from providing the full Dolby Digital surround-sound effect.

You can override this configuration by completing the following steps.

1. Press **SETTINGS** twice on the remote control to open the General Settings menu.
2. Press **MOVE UP** or **MOVE DOWN** to select the option Audio: Digital Out.
3. Press **MOVE RIGHT** to select Dolby Digital. This setting will send Dolby Digital audio to the HDMI, DIGITAL AUDIO OUT, and OPTICAL AUDIO OUT connectors on the set-top.

Notes:

- If the TV is not Dolby Digital capable, it may not produce audio through its speakers when the Audio: Digital Out setting on the set-top is set to Dolby Digital. You can either switch the Audio: Digital Out setting back to HDMI when you are not using the home theater or Dolby Digital decoder, or you can connect the baseband audio outputs (OUT 1 Audio Left and Right) to the TV.
- Digital content is encrypted with High-Bandwidth Content Protection (HDCP) on the DVI/HDMI port. This set-top is not compatible with devices that do not support HDCP. You must use either the YPbPr or 1394 connection to connect the set-top to these devices.

Connecting to an HDTV with a DVI Connector



WARNING: Electric shock hazard! Unplug all electronic devices before connecting or disconnecting any device cables to the set-top.

Required cables:

- 1 HDMI-to-DVI or 1 HDMI cable and 1 DVI adapter
- 1 audio Left/Right cable

Back of Set-Top

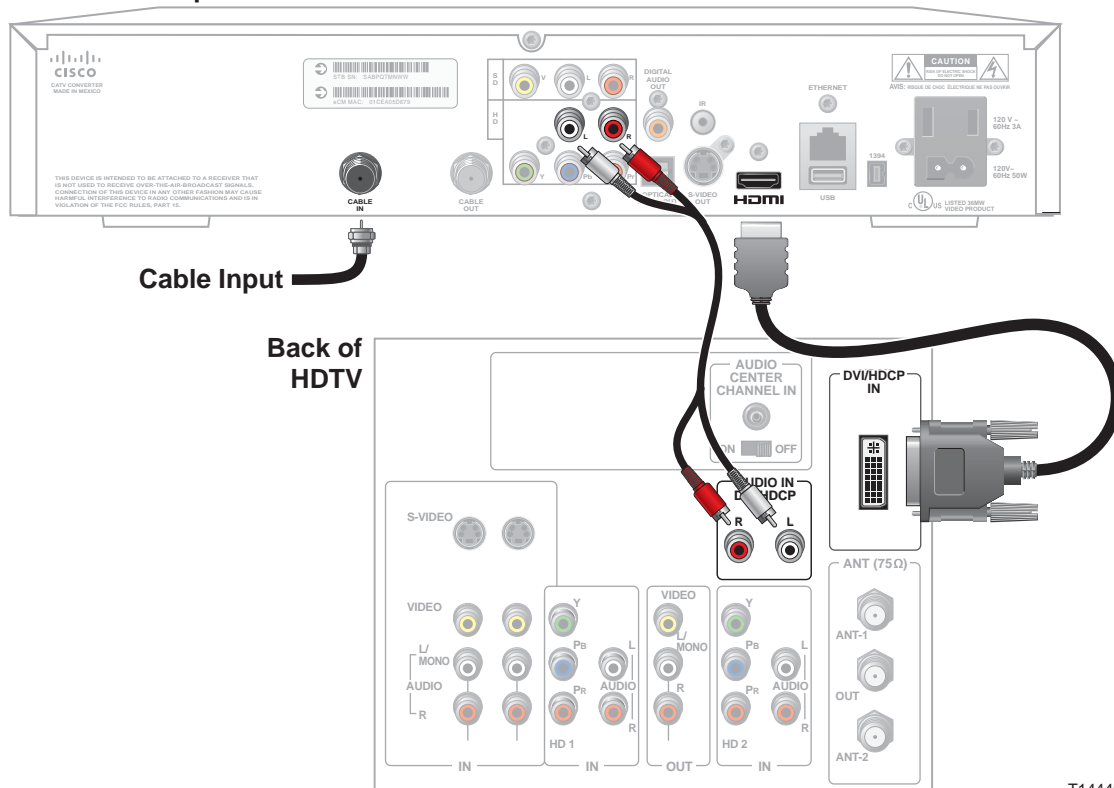

T14449

Notes:

- When you connect the HDMI connector to the DVI connector on your HDTV, you need an HDMI-to-DVI adaptor and a separate audio connection.
- Digital content is encrypted with High-Bandwidth Content Protection (HDCP) on the DVI/HDMI port. This set-top is not compatible with devices that do not support HDCP. You must use either the YPbPr or 1394 connection (which uses Digital Transmission Content Protection, or DTCP) to connect the set-top to these devices.
- Also refer to the **Important Note Regarding the HDMI Interface on the Set-Top** on page 12.

Connecting to an HDTV with Component Input (YPbPr)



WARNING: Electric shock hazard! Unplug all electronic devices before connecting or disconnecting any device cables to the set-top.

Required cables:

- 1 component video cable with 3 connectors (YPbPr)
- 1 audio Left/Right cable

Back of Set-Top

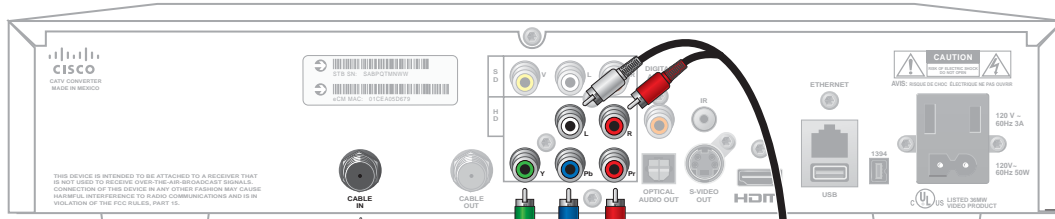

Cable Input

Back of
HDTV

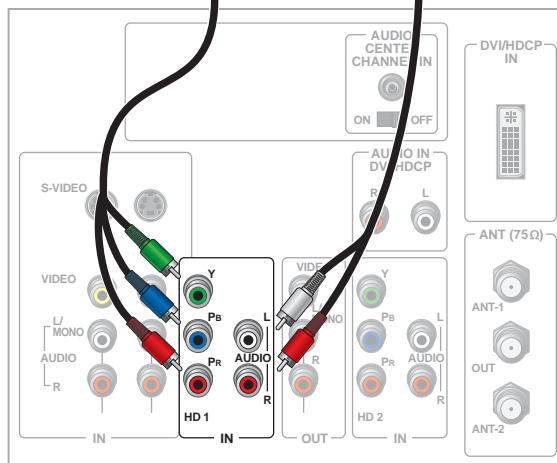

T14450

Connecting to a Home Theater System with Component Input (YPbPr)



WARNING: Electric shock hazard! Unplug all electronic devices before connecting or disconnecting any device cables to the set-top.

Required cables:

- 1 component video cable with 3 connectors (YPbPr)
- 1 digital audio cable

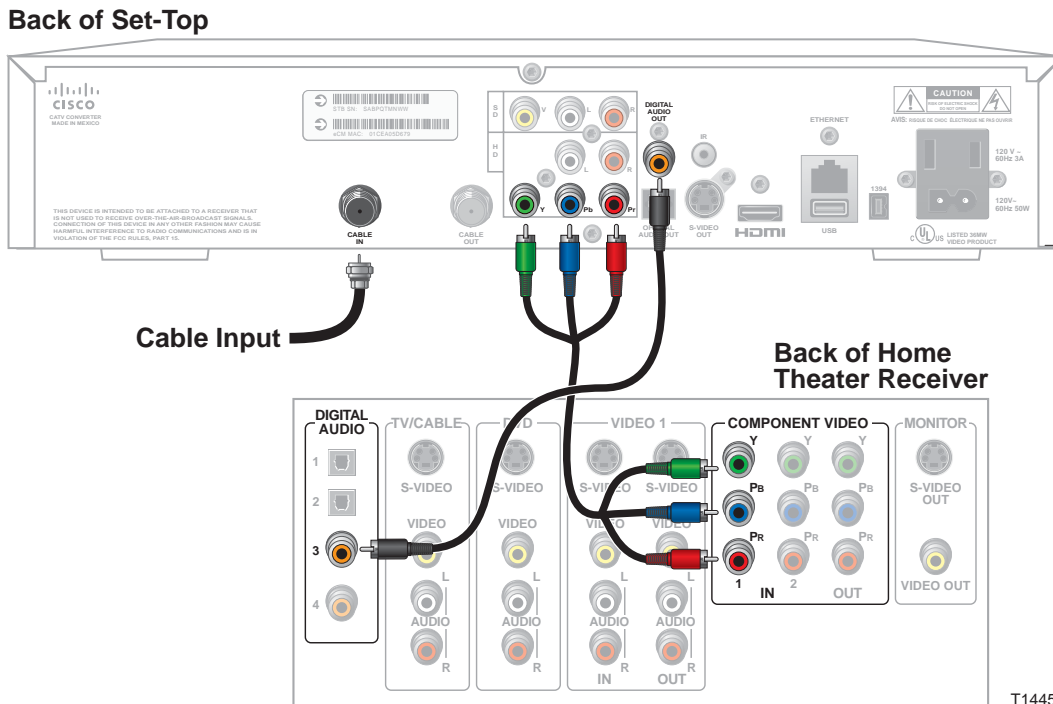

Connecting to a Stereo VCR and HDTV (optional)



WARNING: Electric shock hazard! Unplug all electronic devices before connecting or disconnecting any device cables to the set-top.

Required cables:

- 1 RF coaxial cable
- 2 composite video cables
- 2 audio Left/Right cables

Back of Set-Top

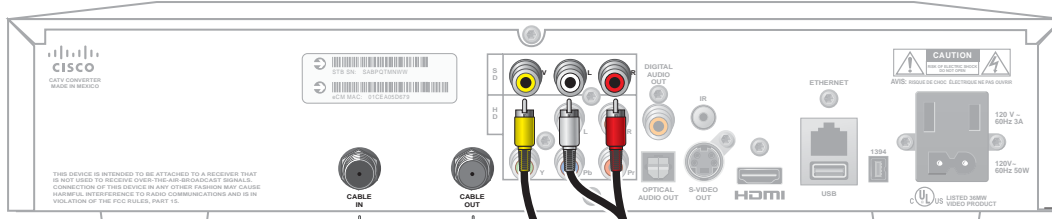

Cable Input

Note: This connection allows for recording to the VCR and for watching VCR tapes on your HDTV. To watch HD content, use the HDMI, YPbPr, or DVI connector.

Back of Stereo VCR

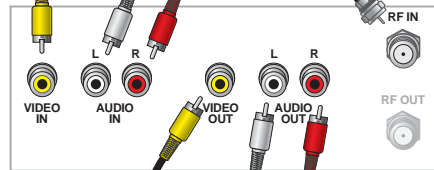

Back of HDTV

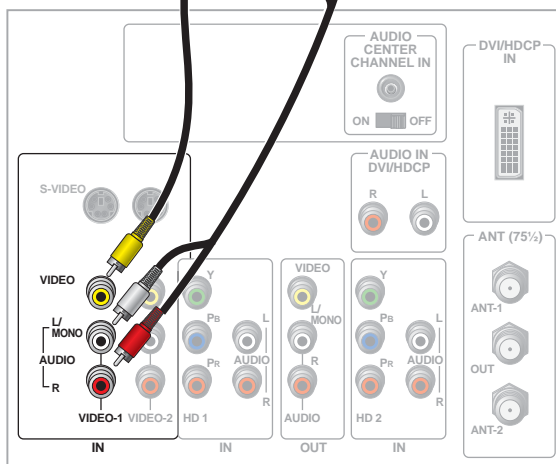

T14452

Connecting to an HDTV with a 1394 Connector



WARNING: Electric shock hazard! Unplug all electronic devices before connecting or disconnecting any device cables to the set-top.

Required cables:

- 1 4-pin to 4-pin 1394 cable (Consult your TV user guide)
- 1 audio Left/Right cable
- 1 component video cable with 3 connectors (YPbPr)

Back of Set-Top

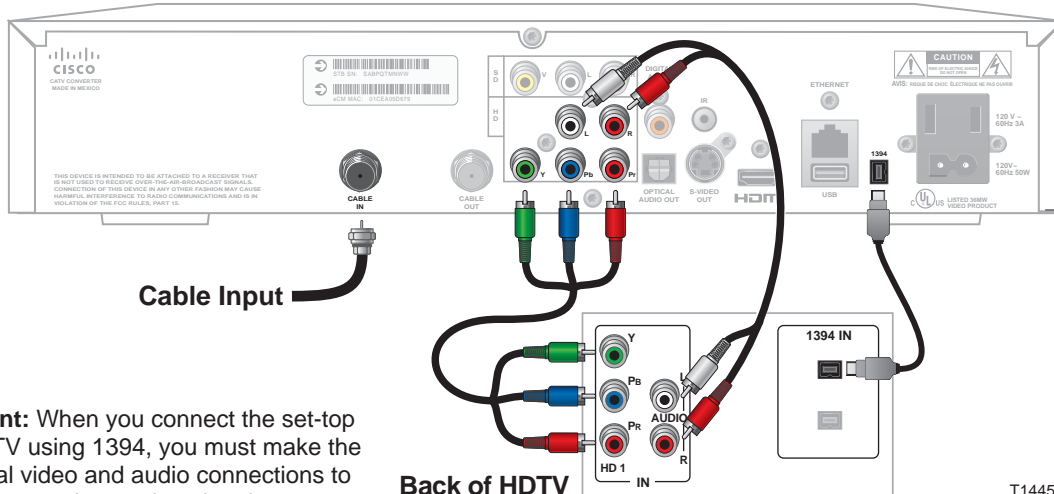

Important: When you connect the set-top to your TV using 1394, you must make the additional video and audio connections to your TV to receive analog signals.

Back of HDTV

T14453

Connecting the Set-Top in HD Mode to an SDTV with Component Input (YPbPr)



WARNING: Electric shock hazard! Unplug all electronic devices before connecting or disconnecting any device cables to the set-top.

Required cables:

- 1 component video cable with 3 connectors (YPbPr)
- 1 audio Left/Right cable

Back of Set-Top

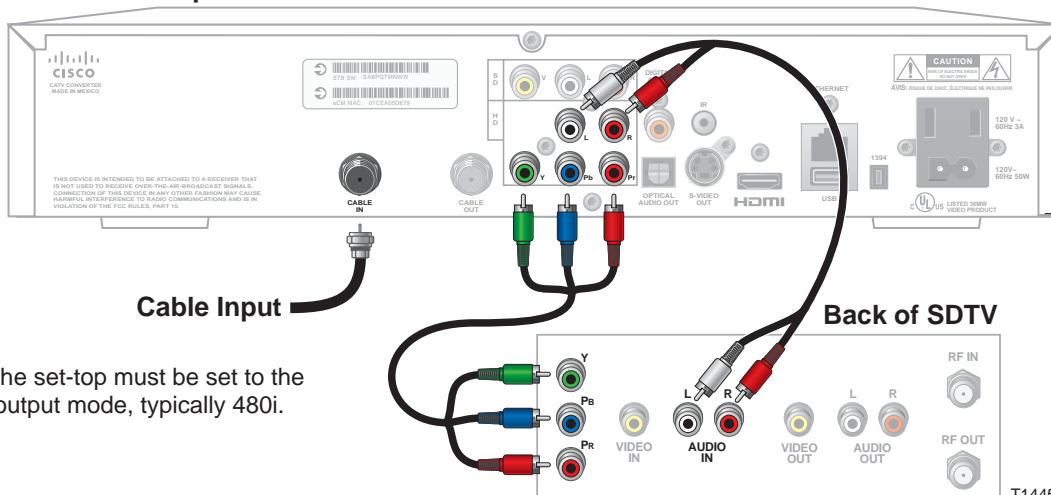

Note: The set-top must be set to the proper output mode, typically 480i.

Back of SDTV

T14454

Index

1394 Firewire 4, 6, 17

A

AC

- Outlet iv, 4
- Power input 4

Aspect ratio 11

B

- Back panel 4
- Burn-in of screen 8

C

- Cables 2
- Cable Out, connector 4
- Compliance, FCC and Canadian EMI 20
- Component video connection. *See* YPbPr
- Composite 7
- Connectors
 - See also* Front panel; Back panel
 - required for HDTV 6
 - required for SDTV 7
 - VCR 6, 7
- Connecting the set-top to other devices;
 - HDTV with 1394 connector 17
 - HDTV with component input (YPbPr) 14
 - HDTV with DVI connector 13
 - HDTV with HDMI connector 12
 - HDTV with VCR 16
 - Home Theater System with component input (YPbPr) 15
 - SDTV 17

Controls. *See* Front panel

D

- Dashes display 5
- Diagrams. *See* Connecting the set-top to other devices
- Digital TV, What is it 10
- Display, LED 3
- DVI connector 2, 4, 6, 13

F

- FAQs 10
- FCC compliance 20
- Formats, picture 11
- Frequently Asked Questions. *See* FAQs
- Front panel 3

H

HD

- broadcasting 10
- mode 4, 5, 6, 7, 17
- format 1, 10

HDTV

- Connections 6
- formats 11
- What is it 10

HDMI 4, 6, 12

High-definition. *See* HD

Home theater system connection 15

I

- Interlaced scan rate 11
- IR Sensor 3

K

Keys. *See* Front panel; Back panel

L

LED Display 3

P

Picture

- Doesn't display 9
- Formats 11
- No color 9
- Ports. *See* Connectors
- Product information 1
- Programming, viewing 8
- Progressive scan rate 11

Index, continued

R

- Remote control 8
- RGB connector. See YPbPr

S

- S-Video 7
- Safety ii, iv-v
- Scan rates 11
- Screen
 - burn-in 8
 - resolution 11
 - size 11
- SD mode 4, 5, 7, 17
- SDTV
 - Connections 7, 17
 - What is it 10
- Serial number, locating 1
- Set-top. See Welcome
- Software updates 9
- Sound, troubleshooting 9
- Standard-definition, What is it 10
- Standard-screen TV 11
- Stretching and zooming picture 8, 11

T

- Time display 5
- Troubleshooting 9
- TV
 - digital, what is it 10
 - formats 11
 - HDTV, what is it 10
 - programming 8
 - resolution 11
 - standard-screen 11
 - standard-definition, What is it 10
 - wide-screen 11

U

- Updating, software 9
- USB port 3

V

- VCR connection 6, 7, 16
- View programs 8

W

- Watch TV 1, 8
- Web access to product information 1
- Welcome 1
- Wide-screen TV 11

Y

- YPbPr
 - connector 4, 6, 7
 - HDTV connection 14
 - home theater connection 15
 - SDTV connection 17

Z

- Zoom picture 8, 11

FCC Compliance

United States FCC Compliance

This device has been tested and found to comply with the limits for a Class B digital device, pursuant to part 15 of the FCC Rules. These limits are designed to provide reasonable protection against such interference in a residential installation. This equipment generates, uses, and can radiate radio frequency energy. If not installed and used in accordance with the instructions, it may cause harmful interference to radio communications. However, there is no guarantee that interference will not occur in a particular installation. If this equipment does cause harmful interference to radio or television reception, which can be determined by turning the equipment OFF and ON, the user is encouraged to try to correct the interference by one or more of the following measures:

- Reorient or relocate the receiving antenna.
- Increase the separation between the equipment and receiver.
- Connect the equipment into an outlet on a circuit different from that to which the receiver is connected.
- Consult the service provider or an experienced radio/television technician for help.

Any changes or modifications not expressly approved by Cisco Systems, Inc., could void the user's authority to operate the equipment.

The information shown in the FCC Declaration of Conformity paragraph below is a requirement of the FCC and is intended to supply you with information regarding the FCC approval of this device. *The phone numbers listed are for FCC-related questions only and not intended for questions regarding the connection or operation for this device. Please contact your service provider for any questions you may have regarding the operation or installation of this device.*

FCC Declaration of Conformity

This device complies with Part 15 of FCC Rules. Operation is subject to the following two conditions: 1) the device may not cause harmful interference, and 2) the device must accept any interference received, including interference that may cause undesired operation.

Explorer 4640HD, 4642HD, 4650HD, and 4652HD Set-Tops
Model: 4640HD, 4642HD, 4650HD, and 4652HD
Manufactured by: Cisco Systems, Inc.
5030 Sugarloaf Parkway
Lawrenceville, Georgia 30044 USA
Telephone: **770-236-1077**

Canada EMI Regulation

This Class B digital apparatus complies with Canadian ICES-003.

Cet appareil numérique de la class B est conforme à la norme NMB-003 du Canada.

20081121 FCC Standard

Software and Firmware Use

The software described in this document is protected by copyright law and furnished to you under a license agreement. You may only use or copy this software in accordance with the terms of your license agreement.

The firmware in this equipment is protected by copyright law. You may only use the firmware in the equipment in which it is provided. Any reproduction or distribution of this firmware, or any portion of it, without our express written consent is prohibited.

Disclaimer

Cisco Systems, Inc. assumes no responsibility for errors or omissions that may appear in this guide. We reserve the right to change this guide at any time without notice.

AVC VIDEO LICENSE

With respect to each AVC/H.264 product, we are obligated to provide the following notice:

THIS PRODUCT IS LICENSED UNDER THE AVC PATENT PORTFOLIO LICENSE FOR THE PERSONAL AND NON-COMMERCIAL USE OF A CONSUMER TO (i) ENCODE VIDEO IN COMPLIANCE WITH THE AVC STANDARD ("AVC VIDEO") AND/OR (ii) DECODE AVC VIDEO THAT WAS ENCODED BY A CONSUMER ENGAGED IN A PERSONAL AND NON-COMMERCIAL ACTIVITY AND/OR WAS OBTAINED FROM A VIDEO PROVIDER LICENSED TO PROVIDE AVC VIDEO. NO LICENSE IS GRANTED OR SHALL BE IMPLIED FOR ANY OTHER USE. ADDITIONAL INFORMATION MAY BE OBTAINED FROM MPEG LA, L.L.C. SEE [HTTP://WWW.MPEGLA.COM](http://www.mpegla.com).

Accordingly, please be advised that service providers, content providers, and broadcasters are required to obtain a separate use license from MPEG LA prior to any use of AVC/H.264 encoders and/or decoders.



Cisco Systems, Inc.
5030 Sugarloaf Parkway, Box 465447
Lawrenceville, GA 30042

678.277.1000

www.cisco.com

Cisco and the Cisco Logo are trademarks of Cisco Systems, Inc. and/or its affiliates in the U.S. and other countries. A listing of Cisco's trademarks can be found at www.cisco.com/go/trademarks.

Manufactured under license from Dolby Laboratories. Dolby is a trademark of Dolby Laboratories.

HDMI, the HDMI logo, and High-Definition Multimedia Interface are trademarks or registered trademarks of HDMI Licensing LLC.

Macrovision is a registered trademark of Macrovision Corp.

MoCA is a trademark of the Multimedia over Coax Alliance.

Other third party trademarks mentioned are the property of their respective owners.

The use of the word partner does not imply a partnership relationship between Cisco and any other company. (1005R)

© 2010 Cisco Systems, Inc. All rights reserved.

July 2010

Printed in United States of America

Part Number 4029077 Rev A